

ACCS INSTRUCTIONS TO ARCHITECTS AND ENGINEERS

Table of Contents

GENERAL.....	6
Revision History	6
Introduction	7
Document Organization.....	7
Document Purpose.....	7
Building Code	7
Design	7
Building and Construction Cost Estimates	8
General Information	9
Drawings and Specifications	9
Space Type.....	10
Space Definitions.....	10
Space Type Standards	10
ASTM UNIFORMAT II	31
A: SUBSTRUCTURE	33
Revision History	33
A10: Foundations	34
A1010: Standard Foundations	34
A1020: Special Foundations	34
A1030: Slab on Grade.....	34
A20: Basement Construction	34
A2010: Basement Excavation	34
A2020: Basement Walls	34
B: SHELL.....	35
Revision History	35
B10: Superstructure	36
B1010: Floor Construction	36
B1020: Roof Construction	36
B20: Exterior Enclosure.....	36
B2010: Exterior Walls	36



ACCS INSTRUCTIONS TO ARCHITECTS AND ENGINEERS

B2020: Exterior Windows.....	36
B2030: Exterior Doors	37
B30: Roofing.....	37
B3010: Roof Coverings	37
B3020: Roof Openings.....	40
C: INTERIORS	41
Revision History	41
C10: Interior Construction	42
C1010: Partitions	42
C1020: Interior Doors.....	42
C1030: Fittings.....	43
C20: Stairs	46
C2010: Stair Construction	46
C2020: Stair Finishes	46
C30: Interior Finishes.....	46
C3010: Wall Finishes.....	46
C3020: Floor Finishes.....	47
C3030: Ceiling Finishes.....	48
D: SERVICES.....	49
Revision History	49
D10: Conveying	50
D1010: Elevators & Lifts	50
D1020: Escalators & Moving Walks	50
D1030: Other Conveying Systems.....	50
D20: Plumbing.....	50
D2010: Plumbing Fixtures.....	50
D2020: Domestic Water Distribution.....	51
D2030: Sanitary Waste	52
D2040: Rain Water Damage.....	52
D2090: Other Plumbing Systems	52
D30: HVAC	52
D3010: Energy Supply	54
D3020: Heat Generating Systems	54



ACCS INSTRUCTIONS TO ARCHITECTS AND ENGINEERS

D3030: Cooling Generating Systems	54
D3040: Distribution Systems	54
D3050: Terminal & Package Units.....	54
D3060: Controls & Instrumentation	55
D3070: Systems Testing & Balancing.....	58
D3090: Other HVAC Systems & Equipment	58
D40: Fire Protection	58
D4010: Sprinklers	58
D4020: Standpipes	58
D4030: Fire Protection Specialties	58
D4090: Other Fire Protection Systems	59
D50: Electrical.....	59
D5010: Electrical Service & Distribution.....	59
D5020: Lighting and Branch Wiring	59
D5030: Communication & Security	60
D5090: Other Electrical Systems	66
E: EQUIPMENT & FURNISHINGS	67
Revision History	67
E10: Equipment.....	68
E1010: Commercial Equipment	68
E1020: Institutional Equipment	68
E1030: Vehicular Equipment	68
E1090: Other Equipment	68
E20: Furnishings.....	68
E2010: Fixed Furnishings	68
E2020: Movable Furnishings	69
F: SPECIAL CONSTRUCTION & DEMOLITION	70
Revision History	70
F10: Special Construction	71
F1010: Special Structures	71
F1020: Integrated Construction	71
F1030: Special Construction Systems.....	71
F1040: Special Facilities.....	71



ACCS INSTRUCTIONS TO ARCHITECTS AND ENGINEERS

F1050: Special Controls and Instrumentation	71
F20: Selective Building Demolition	71
F2010: Building Elements Demolition	71
F2020: Hazardous Components Abatement.....	71
G: BUILDING SITEWORK.....	72
Revision History	72
G10: Site Preparation.....	73
G1010: Site Clearing	73
G1020: Site Demolition and Relocations	73
G1030: Site Earthwork.....	73
G1040: Hazardous Waste Remediation	73
G20: Site Improvements	73
G2010: Roadways	73
G2020: Parking Lots	73
G2030: Pedestrian Paving.....	73
G2040: Site Development.....	73
G2050: Landscaping	74
G30: Site Mechanical Utilities	77
G3010: Water Supply	77
G3020: Sanitary Sewer	77
G3030: Storm Sewer	77
G3040: Heating Distribution	77
G3050: Cooling Distribution	77
G3060: Fuel Distribution	77
G3090: Other Site Mechanical Utilities.....	77
G40: Site Electrical Utilities.....	77
G4010: Electrical Distribution.....	77
G4020: Site Lighting	77
G4030: Site Communications & Security.....	77
G4090: Other Site Electrical Utilities	77
G90: Other Site Constructions	77
G9010: Service and Pedestrian Tunnels	77
G9090: Other Site Systems & Equipment	77



ACCS INSTRUCTIONS TO ARCHITECTS AND ENGINEERS

APPENDIX A – FORMS	78
APPENDIX B – SUPPORTING DOCUMENTS.....	78
SPACE NAMING GUIDELINES.....	79
ACCS Facilities Project File Naming Standard	89
CHECKLIST	92



ACCS INSTRUCTIONS TO ARCHITECTS AND ENGINEERS

GENERAL

Revision History

Section	Summary of Change	Revision Date
Document Purpose	Budget and Construction Cost Estimates - Allowances	5/17/24
Space Type Standards	Study Space Planning	5/17/24
General Information	Board approved projects blackout bid dates and prebid mtg	10/3/24
Drawings and Specifications	Architectural flythrough of new construction of buildings	2/10/25



ACCS INSTRUCTIONS TO ARCHITECTS AND ENGINEERS

Introduction

This document contains design and specification considerations that must be adhered to by the designing Architect/Engineer (A/E) and all consultants involved in the design process.

Variance from these design standards and considerations can be requested by Architect/Engineer and will be reviewed by ACCS. If variance is approved, a copy of the variance will be inserted into the design documents project manual.

Recommendations for changes to this document are welcome and can be submitted to ACCS. The recommendation is reviewed by ACCS and if accepted will be incorporated into this document.

Document Organization

This document is currently organized by General Instructions to Architects and Engineers, Space Types, and ASTM Uniformat II. Some instructions are intentionally repeated in several sections to ensure they are easily referenced and followed.

Document Purpose

The purpose of the document is to provide the design professionals with minimum standards for designing facilities owned by the Alabama Community College System. These standards apply to all facilities owned and/or leased by the Alabama Community College System. Leased facilities that are not owned by the Alabama Community College System may not be subject to the standards required in this document. Variance from these standards requires written approval from the Alabama Community College System's Facilities Division.

Building Code

Refer to the most current revision of the ACCS Construction Manual of Procedures.

Design

Exterior Aesthetic: Prior to beginning schematic design for a project, Design Professionals shall study the existing architecture and overall planning of campus infrastructure and



ACCS INSTRUCTIONS TO ARCHITECTS AND ENGINEERS

elements to establish design parameters for the specific project. These parameters shall be discussed with the College and ACCS Facilities Division prior to starting any design.

Campus Architecture in the Alabama Community College System varies from college to college and campus to campus. College Presidents are required to develop a vision for what the image and character of their College's campuses should be. Design Professionals are encouraged to help the President and College realize and refine this vision in every project they engage in. Design professionals shall evaluate nearby campus features and existing facilities scale, proportions, materials, height, etc. to ensure that a new or renovated building does not alienate itself from the rest of the campus.

All conceptual designs and associated design narratives shall be approved by the ACCS Facilities Division prior to progressing into the schematic, preliminary and/or final design stages of a project.

Design Professionals shall be responsible for ensuring that exterior materials and features are easy to maintain, repair and/or replace. Overly designed, customized spaces that contain rare materials and/or equipment should be avoided.

Interior Aesthetic: Colleges need to have the interiors of their facilities designed to meet the program needs of their students, faculty, and staff. The interior aesthetic of a space will meet the desires of the College and President. Design Professionals are, again, encouraged to help the President and College realize and refine their ideas in every project they engage in.

Design Professionals shall be responsible for ensuring that interior designs and associated FF&E are easy to maintain, repair and/or replace. Overly designed, customized spaces that contain rare materials and/or equipment should be avoided.

Building and Construction Cost Estimates

- The selected Design Professional will include all relevant construction costs in the budgeting process. ALL costs shall be taken into consideration, including direct purchases.
 - Information Technology/data equipment, furniture, soil reports, surveys, construction testing, landscaping, interior and exterior trash receptacles, hand dryers, interior and exterior signage, carpet, lock, and keying core allowance etc.... Design Professionals shall designate each item as one of the following:
 - Contractor Furnished; Contractor Installed (CFCl)
 - Contractor Furnished; Owner Installed (CFOI)
 - Owner Furnished; Contractor Installed (OFCl)
 - Owner Furnished; Owner Installed (OFOI)



ACCS INSTRUCTIONS TO ARCHITECTS AND ENGINEERS

- The costs and designated responsibilities of items listed above shall be reviewed and coordinated with the College and ACCS Facilities Division for final approval.
- Allowances may be used, but only with Unit Prices. Use of Allowances without Unit Prices is only with ACCS written approval.

General Information

- For projects that require Board approval, bid openings should not occur from the 25th of the month through the 10th of the following month.
- For projects that require Board approval, a Pre-Bid meeting is required.

Drawings and Specifications

- Electronic Copies: Design Professional will provide pdf copies of all bid documents, drawings and specifications to the Owner immediately following approval of successful bid. Following the notice of completion of the project the A/E will provide an electronic copy of the floor plans including all changes that took place during construction. The drawings will include at minimum, the floor plans with room numbers, the door and window locations, roof plans and exterior elevations of the building submitted in AutoCAD format. It will also include the location of all mechanical and electrical equipment.
- Architectural Flythrough: Design professional shall provide architectural flythrough of new construction of buildings as part of their basic fee of services.
- Equipment Specifications: Design Professional is only to specify equipment with replacement parts distributed in North America. This instruction is for all types and categories of equipment specified. If any part of the equipment is not commonly distributed in North America, it is not to be specified.
- Room Numbers: At the completion of design development drawings, the architect will submit an electronic copy of the floor plans. The Design Professional will develop room numbers based on requirements from College. The owner assigned room numbers will be printed on all “for construction” documents to ensure proper labeling of electrical panels, fire alarm system, HVAC controls, key/lock inventory and so forth. These numbers will also be used for room number signs to be furnished and installed by the owner prior to the final punch list being completed. See Appendix B for Space Naming Guidelines.
- **APPROVALS and ACCEPTANCE**: Before project bidding at a minimum the following must approve and sign off on specifications and drawings to ensure proper design and adherence to Instructions.
 - ACCS Regional Project & Facilities Director



ACCS INSTRUCTIONS TO ARCHITECTS AND ENGINEERS

Space Type

This section contains instructions and considerations of design of specific space types. Definition of these space types is provided by the Postsecondary Education Facilities Inventory and Classification Manual – May 2006 (FICM Manual). Standards for these space types are found after the definition.

Space Definitions

Gross Area – The total floor area of the structure within the outside faces of the exterior walls. This is also referred to as Gross Square Feet (GSF).

Net Assignable Area – The sum of all areas on all floors of a building assigned to, or available for assignment to, as occupant or use, excluding spaces defined as building service, circulation, mechanical, and structural areas. This is also referred to as Net Assignable Square Feet (NASF).

Space Type Standards

Administrative Space Planning		
Room Type	Area (NASF)	Commentary
President's Office	275-325	
Dean and Vice-President Office	200-250	
Director/Department Head Office	140-160	
Faculty Office	100-120	
Adjunct Faculty Offices	64-80	
Faculty workstations (FF&E)	32-64	
Adjunct Faculty workstations (FF&E)	32-64	
Flex/Shared workstations (FF&E)	32-64	
Conference/Meeting Room	N/A	Area dictated by required number of occupants.



ACCS INSTRUCTIONS TO ARCHITECTS AND ENGINEERS

Study Space Planning		
Room Type	Area (NASF)	Commentary
Library	500-1500	Depends on College size and enrollment. Smaller colleges would be closer to 500 and larger colleges be closer to 1500.
Student Group Study Rooms	Area varies. Sized for 4-8 people.	Provide space for no less than 4 (four) occupants. Connections: TV monitors and Wi-Fi required.
Student Study Stations (FF&E)	Determined by desired seat count.	Power connections for task lighting, personal devices required. Coordinate with furniture supplier to ensure connections are located correctly. (laptops, tablets, cell phones, etc.)



ACCS INSTRUCTIONS TO ARCHITECTS AND ENGINEERS

Auxiliary Space Planning		
Room Type	Area (Maximum)	Commentary
Primary Custodial Closet	100-130	Include mop sink; Storage for custodial cart, vacuum, supplies, mops, brooms, etc.; mop racks must hang over sinks.
Secondary Custodial Closet	48-64	Storage for supplies
IT/Telecom (Main Distribution Frame)	64-100	Painted plywood walls for mounting equip; Climate controlled.
IT/Telecom (Intermediate Distribution Frame)	32-48	Painted plywood walls for mounting equip; room must be well ventilated to climate-controlled space or climate controlled itself.
AV Closet	10-32	Wall or floor mounted cabinets also permitted
Break Rooms	Size varies based on end-user needs. Shared usage among multiple departments encouraged.	Include utilities connections for refrigerators, sinks, coffee makers and microwaves. Dishwashers and garbage disposals are not recommended.
Work Rooms	Size varies based on end-user needs. Shared usage among multiple departments encouraged. When possible, share with break room.	Include power and data connections for printer/copiers. When necessary incorporate sending/receiving for mail. Include millwork/casework for paper storage and office supplies.

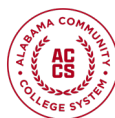

ACCS INSTRUCTIONS TO ARCHITECTS AND ENGINEERS

General Classroom Space Planning		
Room Type	Area (Maximum)	Commentary
General Education Classroom	Determined by desired seat count.	Review needs of space with College. General classrooms should accommodate a wide variety of teaching formats to ensure maximum utilization.
Science Wet Lab	Determined by desired seat count.	Fume hoods shall have the ability to be turned on/off while allowing the lab to still function. Fume hoods should be designed in a manner that noise created by its use does not disrupt other activities in the building.
Science Dry Lab	Determined by desired seat count.	Same as general education classroom, but with adequate secure storage to lab supplies and equipment.



ACCS INSTRUCTIONS TO ARCHITECTS AND ENGINEERS

Workforce Space Planning		
Room Type	Area (Recommended)	Commentary
Drafting/Graphic Design/Computer Labs		
Cosmetology		
Construction - HVAC Training		
Construction - Electrical Training		
Construction - Trades/Construction Sciences		
Construction - Marine Technology		
Construction - Welding		
Construction - Masonry		
Health Science - Nursing		
Health Science - Emergency Medical Services		
Health Science - Physical Therapy		
Health Science - Veterinary Technician		
Mechatronics/Industrial Electronics		
Advanced Composites		
Aircraft Maintenance Technology		
Automotive - Diesel Mechanics		
Automotive - General Mechanics		
Automotive - Autobody Repair		
Horticulture/Turf management		
Forestry		
Commercial Driving License (CDL)		
Heavy Machinery Training		
Lineman Training		



ACCS INSTRUCTIONS TO ARCHITECTS AND ENGINEERS

Classroom – A room or space primarily used for scheduled instruction and that is not tied to a specific subject or discipline by equipment in the room or the configuration of the space.

Classroom
Technology
Provide lectern station/instruction desk with power, a/v control access to monitors and projectors.
Provide a/v wall mounted cabinet or closet to serve the classroom technology needs.
All Classrooms are required to have magnetic dry eraser whiteboards.
All Classrooms are required to have access to Wi-Fi.
All Classrooms are required to have tv monitor and/or projection systems. TV Monitor or Smart Board system preferred by ACCS.
All Classrooms are required to be equipped with infrastructure to install wall mounted tv monitor, pan tilt zoom camera and projection system. (i.e., wall blocking, power, HDMI, coax, CAT 6, etc.)
Review supplemental requirements with college president and/or Owner’s Designated Rep.
Windows
Any classroom with windows shall have dual roller window screens with solar and blackout treatment. Treatments are permitted to be manual. Motorized window treatments must be approved by ACCS.
Lighting
Lighting controls - All classrooms shall have dimmable, zoned controls to allow the classroom to be dimmed from front of the class to the rear of the class. Lighting controls are required to be preset with no more than 3 dimmable zones. Two zones preferred. Zones shall be approved by the college.
Light fixtures: 2x4 or 2x2 LED (special classrooms identified by College may supplement lighting with LED down lights and LED cove lighting.)
Lighting Color Temp: 3500
Lighting Foot Candle: Average maintained level of 40 FC minimum. No area shall be less than 30 FC.
Finishes
Carpet Tile or LVT; Carpet tile recommended.
Base: 4” Rubber



ACCS INSTRUCTIONS TO ARCHITECTS AND ENGINEERS

Wall: Gypsum board; painted (satin)
Ceiling: 2x2 Acoustical Ceiling Tile
Access Control/Hardware
Doors: Solid Wood w/ accessible viewing glass lite
Hardware: Mortise cylinder Lock – classroom lockset (equal to ASSA ABLOY)
Frame: Hollow Metal Frame



ACCS INSTRUCTIONS TO ARCHITECTS AND ENGINEERS

Laboratory – A space characterized by special purpose equipment or a specific configuration that limits instructional or research activities to a particular discipline or a closely related group of disciplines.

Laboratory
Technology
Provide lectern station/instruction desk with power, a/v control access to monitors and projectors.
Provide a/v wall mounted cabinet or closet to serve the classroom technology needs.
All Labs are required to have magnetic dry eraser whiteboards.
All Labs are required to have access to Wi-Fi.
All Labs are required to have tv monitor and/or projection systems. TV Monitor or Smart Board system preferred by ACCS.
All Labs are required to be equipped with infrastructure to install wall mounted tv monitor, pan tilt zoom camera and projection system. (i.e., wall blocking, power, HDMI, coax, CAT 6 etc.)
Review supplemental requirements with college president and/or Owner’s Designated Rep.
Fume Hoods (Chemistry Labs)
Facilities make-up air and exhaust should be able function independently of a fume hoods operation. Fume hoods shall have the ability to be switched on and off by the College end-user.
Sounds generated by fume-hood operations shall be isolated from the lab they are operated in.
Plumbing
Provide sinks. Each station or only one location
Gas
Floor drains
Eye wash/showers
Windows
Any classroom with windows shall have dual roller window screens with solar and blackout treatment. Treatments are permitted to be manual or motorized. If motorized, all windows should be controlled with one switch or zoned in a manner that an instructor can operate intuitively.
Lighting



ACCS INSTRUCTIONS TO ARCHITECTS AND ENGINEERS

Lighting controls - All classrooms shall have dimmable, zoned controls to allow the classroom to be dimmed from front of the class to the rear of the class. Lighting controls are required to be preset with no more than 3 dimmable zones. Two zones preferred. Zones shall be approved by the college.
Light fixtures: 2x4 or 2x2 LED (special classrooms identified by College may supplement lighting with LED down lights and LED cove lighting.)
Lighting Color Temp: 3500
Lighting Foot Candle: Average maintained level of 40 FC minimum. No area shall be less than 30 FC.
Finishes
Epoxy, Stained/sealed concrete or LVT
Base: Epoxy or 4" Rubber
Wall: Gypsum board; painted (satin)
Ceiling: 2x2 Acoustical Ceiling Tile
Access Control/Hardware
Doors: Solid Wood w/ accessible viewing glass lite
Hardware: Mortise cylinder Lock – classroom lockset (equal to ASSA ABLOY)
Frame: Hollow Metal Frame
Computer Lab
When utilizing a multipurpose space to accommodate a computer lab, it is recommended to line 3 walls with power and network drops using standard computer tables with cable management.
In the middle of this lab, it is recommended to use active learning tables (have wheels and can be configured in a variety of ways) ideally with 4 locations of power access in the floor.
Depending on the size of the space, the Audio Visual may need multiple displays in addition to the front of the room which will need ceiling power and two network drops.



ACCS INSTRUCTIONS TO ARCHITECTS AND ENGINEERS

Office – A space housing faculty, staff, or students working at one or more desks, tables, or workstations.

Office
Technology
Office Space Standards
Offices are required to have access to Wi-Fi.
All Offices are required to be equipped with infrastructure to install computers, telephones, and printers/scanners/copiers. (i.e., CAT 6 and power)
Review supplemental requirements with college president and/or Owner’s Designated Representative.
Windows
Any office with windows shall have roller window screens with solar treatment. Manual treatments only.
Lighting
Light fixtures: 2x4 or 2x2 LED
Lighting Color Temp: 3500
Lighting Foot Candle: Average maintained level of 40 FC minimum. No specific area shall be less than 30 FC.
Finishes
Carpet Tile or LVT
Base: 4” Rubber
Wall: Gypsum board; painted (satin)
Ceiling: 2x2 Acoustical Ceiling Tile
Access Control/Hardware
Doors: Solid Wood w/ full glass lite
Hardware: Mortise cylinder Lock – Entry lockset (equal to ASSA ABLOY)
Frame: Hollow Metal Frame



ACCS INSTRUCTIONS TO ARCHITECTS AND ENGINEERS

Study Space –

Study
Technology
All Study rooms are required to have access to Wi-Fi.
All Study rooms are required to be equipped with infrastructure to install telephones, TV Monitors/Smart board, and laptop computers. (i.e., wall blocking, CAT 6, and power)
Review supplemental requirements with college president and/or Owner’s Designated Representative.
Windows
Any office with windows shall have roller window screens with solar treatment. Manual treatments only.
Lighting
Light fixtures: 2x4 or 2x2 LED
Lighting Color Temp: 3500
Lighting Foot Candle: Average maintained level of 40 FC minimum. No specific A room or area shall be less than 30 FC. used by individuals to study at their convenience, the space not being restricted to a particular subject or discipline by contained equipment.
Finishes
Carpet Tile or LVT
Base: 4” Rubber
Wall: Gypsum board; painted (satin)
Ceiling: 2x2 Acoustical Ceiling Tile
Access Control/Hardware
Doors: Solid Wood w/ full glass lite
Hardware: Mortise cylinder Lock – Entry lockset (equal to ASSA ABLOY)
Frame: Hollow Metal Frame



ACCS INSTRUCTIONS TO ARCHITECTS AND ENGINEERS

Special Use Space – A space that is sufficiently specialized in its primary activity or function and may provide service to other areas, but its special use or configuration dictates that this area (military training, athletic activity, media production, clinical activities, demonstration, agricultural field activities, and animal and plant shelters) not be coded as a service space.

Special Use
Technology
All Special use spaces are required to have access to Wi-Fi.
Review supplemental requirements with college president and/or Owner’s Designated Representative.
Windows
Any classroom with windows shall have dual roller window screens with solar and blackout treatment. Treatments are permitted to be manual or motorized. If motorized, all windows should be controlled with one switch or zoned in a manner that an instructor can operate intuitively.
Lighting
Light fixtures: 2x4 or 2x2 LED (special classrooms identified by College may supplement lighting with LED down lights and LED cove lighting.)
Lighting Color Temp: 3500-5000 (review with College president and/or Owner’s Designated Representative to meet special use space needs.)
Lighting Foot Candle: Refer to the IEC (Illuminating Engineering Society) Footcandle chart for guidance.
Finishes
Review with College president and/or Owner’s Designated Representative to meet special use space needs.
Access Control/Hardware
Doors: Review with College president and/or Owner’s Designated Representative to meet special use space needs.
Hardware: Review with College president and/or Owner’s Designated Representative to meet special use space needs.
Frame: Hollow Metal Frame



ACCS INSTRUCTIONS TO ARCHITECTS AND ENGINEERS

General Use Space – A space that is characterized by a broader availability to faculty, staff, students, or the public and comprise a campus general service or functional support system (assembly, exhibition, dining, relaxation, merchandising, recreation, general meetings, day care) for the institutional and participant community populations.

General Use
Technology
All general use spaces are required to have access to Wi-Fi.
Review supplemental requirements with college president and/or Owner’s Designated Representative.
Windows
Any classroom with windows shall have dual roller window screens with solar and blackout treatment. Treatments are permitted to be manual or motorized. If motorized, all windows should be controlled with one switch or zoned in a manner that an instructor can operate intuitively.
Lighting
Light fixtures: 2x4 or 2x2 LED (special classrooms identified by College may supplement lighting with LED down lights and LED cove lighting.)
Lighting Color Temp: 3500-5000 (review with College president and/or Owner’s Designated Representative to meet special use space needs.)
Lighting Foot Candle: Refer to the IEC (Illuminating Engineering Society) Footcandle chart for guidance.
Finishes
Review with College president and/or Owner’s Designated Representative to meet general use space needs.
Access Control/Hardware
Doors: Review with College president and/or Owner’s Designated Representative to meet general use space needs.
Hardware: Review with College president and/or Owner’s Designated Representative to meet general use space needs.
Frame: Hollow Metal Frame



ACCS INSTRUCTIONS TO ARCHITECTS AND ENGINEERS

Support Space (Information Technology/Telecommunications) – The Main Distribution Frame (MDF) is the central point of the network, where all network cables converge. The Intermediate Distribution Frame (IDF) is a secondary point that provides connectivity between the MDF, and the devices located on each floor of a building or in a specific area. A centralized space for various auxiliary indirect support systems and services that help keep all institutional programs and activities operational (data processing, telecommunications, shop services, general storage and supply, vehicle storage, printing, shipping, and receiving, laundry and hazardous material areas).

Support
Technology
All MDF and IDF rooms are required to have access to Wi-Fi.
All MDF rooms shall provide no less than (1) 4-inch schedule 40 PVC conduit from the appropriate manhole/handhole to the building MDF room.
Review supplemental requirements with college president, College IT Director, Regional ACCS IT Director and Owner’s Designated Representative.
Windows
Not recommended.
Lighting
Light fixtures: 2x4 or 2x2 LED
Lighting Color Temp: 3500
Lighting FC: Average maintained level of 40 FC minimum. No area shall be less than 30 FC.
Mechanical
Climate control: MDF and IDF rooms are required to be climate controlled.
Finishes
Floor: Concrete
Wall: Plywood; painted
Ceiling: None
Access Control/Hardware
Doors: Solid Wood
Hardware: Mortise cylinder Lock – Entry lockset (equal to ASSA ABLOY)
Frame: Hollow Metal Frame



ACCS INSTRUCTIONS TO ARCHITECTS AND ENGINEERS

Health Care Space – Patient care areas that are in separately organized and budgeted human and animal health care areas (student infirmaries and centers, teaching hospitals, clinics, and veterinary and medical schools) that may also house areas that are classified under different classification codes.

Section not in use.

Residential Space – Housing for students, faculty, staff, and visitors to the institution (some spaces within residential facilities might have different codes like libraries, lounges, study rooms, dining areas and recreation rooms).

Section not in use.



ACCS INSTRUCTIONS TO ARCHITECTS AND ENGINEERS

Unclassified Space –

Unclassified
Storage
Dead space, wherever possible, should be developed for storage.
Windows
Not recommended.
Lighting
Light fixtures: 2x4 Assignable areas that are inactive or 2x2 LED
Lighting Color Temp: 3500
Lighting Foot Candle: Average maintained level unassigned; in the process of 40 FC minimum. No specific area shall be less than 30 FC. being altered, renovated, or converted, or in an unfinished state.
Finishes
Floor: Concrete
Base: None
Wall: Gypsum; painted
Ceiling: 2x2 Acoustical Ceiling Tile
Access Control/Hardware
Doors: Solid Wood
Hardware: Mortise cylinder Lock – Entry lockset (equal to ASSA ABLOY)
Frame: Hollow Metal Frame



ACCS INSTRUCTIONS TO ARCHITECTS AND ENGINEERS

Building Service Space – Areas of a building used for custodial supplies, janitorial sink rooms, janitorial closets, and public restrooms.

- Custodial Facilities: These rooms will not in any case be shared with mechanical, electrical, or communication spaces.

Custodial closets will all be furnished with a floor sink in the back corner with splash guard panels protecting the walls surrounding the sink.

Custodial closets will be found on each floor of a building and at least one will have sufficient space to accommodate large equipment and storage of housekeeping supplies. The minimum dimensions for “Primary Custodial Closet” shall be 9'-4" deep by 7'-4" wide.

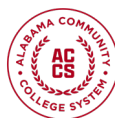

ACCS INSTRUCTIONS TO ARCHITECTS AND ENGINEERS

Restrooms –

Restrooms
Technology
All Restrooms are required to have access to Wi-Fi.
Windows
Windows shall have obscure glazing.
Lighting
Light fixtures: 2x4 or 2x2 LED
Lighting Color Temp: 3500
Lighting Foot Candle: Average maintained level of 40 FC minimum. No specific area shall be less than 30 FC.
Finishes
Floor: Porcelain tile
Base: Porcelain tile
Wall: Porcelain tile preferred. 48" tall porcelain tile wainscot on wet walls with painted, moisture resistant gypsum board is also acceptable.
Ceiling: 2x2 Acoustical Ceiling Tile
Access Control/Hardware
Doors: Solid Wood
Hardware: Push/pull entry with door closer
Frame: Hollow Metal Frame
Toilet Partitions: Stainless steel or Solid Plastic
Plumbing
Wall mounted, tankless toilets only, exception urinals)
Flush valves only
Touch free fixtures or manual fixtures are permitted. Battery operated fixtures are prohibited.
No slope floor w/ floor drains. Trap primers required.



ACCS INSTRUCTIONS TO ARCHITECTS AND ENGINEERS

Dispensers
Toilet Paper Dispensers: FF&E item. Located on drawings by Design Professional. (OFCI)
Soap Dispensers: FF&E item. Located on drawings by Design Professional. (OFCI)
Paper Towel Dispensers: FF&E item. Located on drawings by Design Professional. (OFCI)
Air Hand Dryer: Provide at request of college. Battery operated prohibited, High velocity hand dryers only. Acceptable manufacturers: Dyson, Saniflow and Xlerator.



ACCS INSTRUCTIONS TO ARCHITECTS AND ENGINEERS

Circulation Space – Areas of a building required for physical access to some subdivision of space, whether physically bounded by partitions or not.

Circulation	
Technology	
	All corridors are required to have access to Wi-Fi.
Corridors	
	Special consideration should be given to durability of walls in corridors and on columns. Corner guards are required on all outside corners.
Lighting	
	Light fixtures: 2x4 or 2x2 LED (specific corridors identified by College may supplement lighting with LED down lights and LED cove lighting.)
	Lighting Color Temp: 3500 (review with College president and/or Owner’s Designated Representative to meet special use space needs.)
	Lighting Foot Candle: 40 FC Minimum. Refer to the IEC (Illuminating Engineering Society) Footcandle chart for guidance.
Finishes	
	Review with College president and/or Owner’s Designated Representative to meet circulation space needs.



ACCS INSTRUCTIONS TO ARCHITECTS AND ENGINEERS

Mechanical/Electrical Rooms – Areas of a building designed to house mechanical equipment, utility services, and shaft areas.

Mechanical/Electrical
Technology
All Mechanical and Electrical rooms are required to have access to Wi-Fi.
Lighting
Light fixtures: 2x4 or 2x2 LED
Lighting Color Temp: 3500
Lighting Foot Candle: Average maintained level of 40 FC minimum. No specific area shall be less than 30 FC.
Finishes
Floor: Sealed Concrete or epoxy
Base: None or epoxy
Wall: Concrete block or impact/moisture resistant gypsum; painted
Ceiling: None
Access Control/Hardware
Doors: Solid Wood; Exterior painted steel.
Hardware: Mortise cylinder Lock – Storeroom lockset (equal to ASSA ABLOY)
Frame: Hollow Metal Frame



ACCS INSTRUCTIONS TO ARCHITECTS AND ENGINEERS

ASTM UNIFORMAT II

Level I	Level II	Level III
A Substructure	A10 Foundations	A1010 Standard Foundations
		A1020 Special Foundations
		A1030 Slab on Grade
	A20 Basement Construction	A2010 Basement Excavation
		A2020 Basement Walls
B Shell	B10 Superstructure	B1010 Floor Construction
		B1020 Roof Construction
	B20 Exterior Enclosure	B2010 Exterior Walls
		B2020 Exterior Windows
		B2030 Exterior Doors
	B30 Roofing	B3010 Roof Coverings
		B3020 Roof Openings
	C Interiors	C10 Interior Construction
C1020 Interior Doors		
C1030 Fittings		
C20 Stairs		C2010 Stair Construction
		C2020 Stair Finishes
C30 Interior Finishes		C3010 Wall Finishes
		C3020 Floor Finishes
		C3030 Ceiling Finishes
D Services	D10 Conveying	D1010 Elevators & Lifts
		D1020 Escalators & Moving Walks
		D1090 Other Conveying Systems
	D20 Plumbing	D2010 Plumbing Fixtures
		D2020 Domestic Water Distribution
		D2030 Sanitary Waste
		D2040 Rain Water Drainage
		D2090 Other Plumbing Systems
	D30 HVAC	D3010 Energy Supply
		D3020 Heat Generating Systems
		D3030 Cooling Generating Systems
		D3040 Distribution Systems
		D3050 Terminal & Package Units
		D3060 Controls & Instrumentation
		D3070 System Testing & Balancing
		D3090 Other HVAC Systems & Equipment
	D40 Fire Protection	D4010 Sprinklers
		D4020 Standpipes

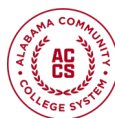

ACCS INSTRUCTIONS TO ARCHITECTS AND ENGINEERS

		D4030 Fire Protection Specialties
		D4090 Other Fire Protection Systems
	D50 Electrical	D5010 Electrical Service & Distribution
		D5020 Lighting and Branch Wiring
		D5030 Communications & Security
		D5090 Other Electrical Systems
E Equipment & Furnishings		E10 Equipment
	E1020 Institutional Equipment	
	E1030 Vehicular Equipment	
	E1090 Other Equipment	
	E20 Furnishings	E2010 Fixed Furnishings
E2020 Movable Furnishings		
F Special Construction & Demolition	F10 Special Construction	F1010 Special Structures
		F1020 Integrated Construction
		F1030 Special Construction Systems
		F1040 Special Facilities
		F1050 Special Controls and Instrumentation
	F20 Selective Building Demolition	F2010 Building Elements Demolition
F2020 Hazardous Components Abatement		
G Sitework & Utilities	G10 Site Preparation	G1010 Site Clearing
		G1020 Site Demolition and Relocations
		G1030 Site Earthwork
		G1040 Hazardous Waste Removal
	G20 Site Improvements	G2010 Roadways
		G2020 Parking Lots
		G2030 Pedestrian Paving
		G2040 Site Development
		G2050 Landscaping
	G30 Site Mechanical Utilities	G3010 Water Supply
		G3020 Sanitary Sewer
		G3030 Storm Sewer
		G3040 Heating Distribution
		G3050 Cooling Distribution
		G3060 Fuel Distribution
		G3090 Other Site Mechanical Utilities
	G40 Site Electrical Utilities	G4010 Electrical Distribution
		G4020 Site Lighting
		G4030 Site Communications & Security
		G4090 Other Site Electrical Utilities
	G90 Other Site Construction	G9010 Services and Pedestrian Tunnels
		G9090 Other Site Systems & Equipment

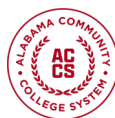

ACCS INSTRUCTIONS TO ARCHITECTS AND ENGINEERS

A: SUBSTRUCTURE

Revision History

Section	Summary of Change	Revision Date



ACCS INSTRUCTIONS TO ARCHITECTS AND ENGINEERS

A10: Foundations

A1010: Standard Foundations

A1020: Special Foundations

A1030: Slab on Grade

A20: Basement Construction

A2010: Basement Excavation

A2020: Basement Walls



ACCS INSTRUCTIONS TO ARCHITECTS AND ENGINEERS

B: SHELL

Revision History

Section	Summary of Change	Revision Date
B2010	Exterior Walls (Mechanical Yards)	5/17/24
B30	Roofing (Modified Bitumen Roof)	5/17/24
B3010	One roof system designed per building	2/10/25
B3010	Roofs - Arbitration	5/15/25
B3010	Roof Coverings	12/17/25

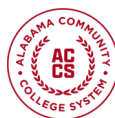

ACCS INSTRUCTIONS TO ARCHITECTS AND ENGINEERS

B10: Superstructure

B1010: Floor Construction

B1020: Roof Construction

B20: Exterior Enclosure

- Silicone: Silicone joint sealants are recommended for exteriors. The best solution is the recommendation from manufacturers of their products (vinyl windows, brick, etc.).

B2010: Exterior Walls

- Brick: Design Professional to provide 3 or 4 brick selections, Owner will pick the color and brick.
- Mechanical Yards: Collections of mechanical units on ground or roof top shall be located in areas without visual prominence from public view. Roof top mechanical units are not preferred and any consideration of locating mechanical units on a roof requires written approval from ACCS Facilities Division. Collections of mechanical units on ground or roof top shall be located in areas that minimize sound nuisance. Mechanical system noise shall not negatively impact campus operations. Mechanical units shall be screened visually when located in partial and/or full public view.

Mechanical yard designs shall consider maintenance access, removal/installation of replacement equipment, necessary safety clearances, and maintenance worker circulation patterns.

- Prohibited Mechanical Yard Screens: Wood fencing and Chain link fencing (central campus locations only).
- Acceptable Mechanical Yard Screens: Concrete/Masonry, Steel (powder coat only), Pre-finished aluminum system, Black vinyl chain link w/ slats (non-central campus locations only).
- Public View is defined as: The general public's (including student, faculty, and staff) view toward primary and secondary campus/building entrances.
- Colors: Architect must provide a color board of all finishes and have them approved by the College prior to the purchase of any finishes. The owner shall be provided with a mockup.

B2020: Exterior Windows

- Windows: Aluminum windows will have exposed mullions and will be double hung.

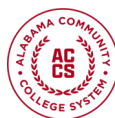

ACCS INSTRUCTIONS TO ARCHITECTS AND ENGINEERS

- Window Maintenance: Provision will be made to wash all windows in the project without the expense of scaffolding or ladders. Windows should be energy efficient. When determining window placement, consideration should be given to the location of the sun to reduce the heating load on the building.

B2030: Exterior Doors

- Doors: The interior of the door will have aluminum kick plates along the bottom.
- Closers: Closers will need to be properly sized to accommodate the size, weight, and use of the door.
- Locks: Locks must be compatible to accept College cores.
- Panic Devices: Panic devices are to be Von Duprin devices or approved equal. When a panic device is included on a door it must be externally mounted.

B30: Roofing

B3010: Roof Coverings

- Arbitration: All Roof Warranty arbitrations will be in the State of Alabama.
- One Roof System: One roof system should be designed per building. ACCS Facilities approval is required when more than one roof system is proposed as a solution to a building design/renovation.
- Modified Bitumen Roof:
 - Administrative
 - Pre-Roofing Conference required before any roofing materials are installed.
 - Execute all operations and provide a safe work environment in accordance with OSHA standards and regulations.
 - Examine site for approved staging areas, disposal sites, and document existing conditions prior to contractor mobilization. Establish scope of work for site restoration and responsibilities.
 - Examine site for condition and completion of areas adjacent to work area. Establish protection required for existing surfaces.
 - Examine deck substrate conditions and finishes for compliance with requirements, including flatness and fastening.
 - Review structural loading limitations of roof deck during and after operations.



ACCS INSTRUCTIONS TO ARCHITECTS AND ENGINEERS

- Review work limitation for contractor including start times, end times, days of the week, noise mitigation, fume control and any other work that would affect normal building operations.
- Review trade coordination necessary for job completion.
- Roofing materials shall be compatible with one another under conditions of service and application required, as demonstrated by roofing system manufacturer based on testing and field experience.
- Installer shall comply with current code requirements based on authority having jurisdiction.
- Roofing system shall meet the intent of systems that have been successfully tested by a qualified testing and inspecting to resist wind uplift pressure calculated in accordance with ASCE 7.
- Roofing membrane, base flashings, and component materials shall comply with requirements in FMG 4450 and FMG 4470 as part of a roofing system and that are listed in FMG’s “RoofNav” for Class 1 or noncombustible construction, as applicable.
- Submittals
 - Confirmation that Installer is approved, authorized, or licensed by manufacturer to install roofing system.
 - Letter from the roofing membrane manufacturer certifying the proposed roofing assembly, compatibility of materials and total R-value of the insulation system.
 - Submit two samples 12 by 12 inches in size illustrating granule surfaced sheet, insulation, and cover boards.
- Approved Manufacturers
 - Approved Manufacturers include (but are not limited to): Johns Manville, SR Products, Soprema, GAF, Tremco and the Garland Company. Other manufacturers with equivalent tested and listed systems meeting all performance criteria shall be reviewed and approved by the architect of record and ACCS Facilities.
- Quality Assurance
 - The manufacturer has UL listing, FMG approval or accredited testing agency listing for roofing system identical to that used for this Project.
 - Independent testing agency with experience and capability to conduct the testing indicated, as documented according to ASTM E 329.
 - Test Reports
 - Infrared Test (for existing roof)
 - Core Test (for existing roof)
 - Roof drain and leader test or submit plumber’s verification
 - The manufacturer shall provide onsite observations at least 2 times weekly during installation accompanied by a written report with photos for each observation. The manufacturer’s representative must be an employee of the manufacturer.



ACCS INSTRUCTIONS TO ARCHITECTS AND ENGINEERS

- Manufacturer to provide documented training with contractor of roof system application prior to installation.
- Installer to be a company specializing in performing this type of roofing system with a minimum of 5 years documented experience and approved by the manufacturer.
- Provided materials must comply with governing regulations that can be installed to comply with the following:
 - UL Fire Classified UL 790 and or ASTM E108.
 - Wind Uplift Resistance: As per local building code and warranty requirements.
- Final Roof Inspection to be inspected by manufacturer's representative upon completion with a notification 48 hours in advance to the Architect and Owner.
- Delivery, Storage and Handling
 - Deliver materials in manufacturer's original containers, dry and undamaged, with seals and labels intact unless otherwise indicated.
 - Store materials in a weather protected environment, clear of ground and moisture; ballast materials may be stored outdoors.
 - Protect foam insulation from direct exposure to sunlight.
- Field Conditions
 - Do not apply roofing membrane when environmental conditions are outside the ranges recommended by manufacturer.
 - Do not apply roofing membrane during unsuitable weather.
 - Schedule applications so that no partially completed sections of roof are left exposed at end of workday.
 - Examine site for approved staging areas, disposal sites, and document existing conditions prior to contractor mobilization.
 - Examine site for condition and completion of areas adjacent to work area. Establish protection required for existing surfaces.
- Project Conditions
 - Start installation of roofing membrane in presence of manufacturer's representative.
 - Coordinate installation of roofing system so insulation and other components of the roofing membrane system not permanently exposed are not subjected to precipitation or left uncovered at the end of the workday or when rain is forecast.
- Warranties
 - Manufacturer shall provide a minimum 20-Year NDL (No Dollar Limit) labor and material warranty covering leaks caused by material failure or workmanship, including wind uplift consistent with code requirements.
 - System Warranty to repair or replace roofing that leaks or is damaged due to wind or other natural causes.
 - Include language of wind-uplift resistance.
 - Hail Resistance Rating: SH-Severe Hail



ACCS INSTRUCTIONS TO ARCHITECTS AND ENGINEERS

- Contractor's 5-Year Warranty
- Completed ACCS Form 6-L General Contractor's Roofing Guarantee
- Execution
 - 2-Ply Roofing System
 - Roof Deck
 - Insulation
 - Cover Board
 - Base Sheet
 - Cap Sheet (color to be white)
 - Emergency overflow drains will be incorporated at all internal drains.
- Single-Ply Roofing: Single-ply roofing systems of any kind – including TPO, PVC, or similar thermoplastic or thermoset membranes – are not permitted.
- Gutters: will be continuous and be covered sufficiently to allow water to enter but prevent leaves from entering. Internal gutters and roof drains are prohibited.

B3020: Roof Openings

- Roof Access: All roofing systems must provide secured access to the roof from the interior or exterior of the building.



ACCS INSTRUCTIONS TO ARCHITECTS AND ENGINEERS

C: INTERIORS

Revision History

Section	Summary of Change	Revision Date
C1020	Closet Spaces	10/3/24
C1020	Door Hardware (Classroom Doors)	10/3/24
C1030	Building Dedication Plaques	10/3/24
C3010	Wall Finishes (Restroom Wall Tile)	10/3/24
C3030	Ceiling Finishes (Suspended Ceiling Grid that meet window frame)	10/3/24
C1030	Toilet Tissue Dispenser Location	10/16/24
C1030	Building Lettering	6/4/25
C3030	Ceiling Finished (Ceiling Tile)	12/17/25
C1030	Building Dedication Plaques	1/23/26
C1010	Restroom Partitions	5/12/26



ACCS INSTRUCTIONS TO ARCHITECTS AND ENGINEERS

C10: Interior Construction

- Colors: Architect must provide a color board of all finishes and have them approved by the College prior to the purchase of any finishes.
- Spacing: All above ceiling Mechanical/Electrical/Plumbing is to be within 18 inches of bar joists or bottom of the roof deck.

C1010: Partitions

- Sound Control between Spaces: Sound insulation is required between rooms, floors, and hallways. This requirement is to be discussed during design.
- Operable Wall Partitions: Reasons for and against the use of operable wall partitions should be discussed during schematic design.
- Restroom Partitions: Restroom partitions shall be phenolic or approved equal by ACCS.

C1020: Interior Doors

- Locks: Locks must be compatible to accept College cores.
- Panic Devices: Panic devices are to be Von Duprin devices or approved equal. When a panic device is included on a door it must be externally mounted.
- Closers: Closers will need to be properly sized to accommodate the size, weight, and use of the door.
- Closet Spaces: During renovations, old closet spaces should not be walled up to create a flush wall and void the existing space.
- Door Hardware: Classroom doors should have a lever, classroom door hardware set with a mortise lock thumb turn.



ACCS INSTRUCTIONS TO ARCHITECTS AND ENGINEERS

C1030: Fittings

- **Building Lettering:** On new construction, or a renamed building, the architect should consider the graphic standard and incorporate a suitable location into the façade design. Text should only consist of the full official name of the building. Text may be 8”, 10”, or 12” depending on the message length and location on the building. The building’s name should be centered over the main entrance, if possible. Any deviations from this building lettering standard shall receive ACCS review and approval.
- **Building Dedication Plaques:** All new buildings should receive a building dedication plaque. For renovated buildings, the choice to install a building dedication plaque is at the discretion of the College and is not required. Building dedication plaques can be installed on the exterior of the building near the main entrance or on the interior of the building just inside the main entrance. If building dedication plaque is installed on the exterior, the plaque should be cast bronze. The interior building dedication plaque can be cast bronze or cast aluminum with bronze finish. The building dedication plaques should have an edge border. Plaques should contain pre-drilled holes in the corners for mounting. Mounting of the plaque should be included in the quote. The mounting height should be 60” from the floor to the center of the plaque. Signage proof shall be submitted to ACCS for review and approval.

The size of the building dedication plaque should be in a vertical position between 18” – 22” in width and between 26” – 32” in height. Font size based on the specific text for each sign and the required spacing. The building dedication plaque should contain the following information (see sample below):

NAME OF THE COLLEGE
NAME OF THE BUILDING
CITY, STATE
ACCS BOARD OF TRUSTEES
NAME GOVERNOR OF ALABAMA
(listing of each Board Member,
starting with the Chair and then Vice Chair,
and the rest of the members alphabetically by last name)
NAME ACCS CHANCELLOR
NAME COLLEGE PRESIDENT
NAME ARCHITECT
NAME CONTRACTOR
COMPLETED (YEAR)



ACCS INSTRUCTIONS TO ARCHITECTS AND ENGINEERS



Recognition Plaque: In addition to the main building dedication plaque, sometimes it may be appropriate to have a secondary recognition plaque of those that helped contribute to the building or renovation. These plaques should be of the same material as the building dedication plaque. The recognition plaque size should be between 8” – 10” in height and between 12” – 16” in width. Font size based on specific text for each sign. The mounting of this plaque should be 4” to the right of the building dedication plaque, 60” from the floor to the center of the plaque. Signage proof shall be submitted to ACCS for review and approval.



ACCS INSTRUCTIONS TO ARCHITECTS AND ENGINEERS



- Toilet Tissue Dispenser Location: Every effort shall be made in the design for toilet paper dispensers to be mounted above the horizontal grab bar in accessible restrooms. If this cannot be accomplished, ACCS must provide approval to move forward with the alternate design. The following diagram provides measurements to achieve the best placement of the dispenser above the horizontal grab bar and to the left of the vertical grab bar. These measurements fall within the ADA and ANSI requirements.
 - Top of the horizontal grab bar to be 33” from the finished floor (ANSI 609.4.1)
 - Center line of the vertical grab bar to be 40” from the rear wall (ANSI 604.5.1.2)
 - Bottom of the protruding toilet tissue dispenser to be mounted 45” from the finished floor (12” above the top of the horizontal grab bar per ADA 609.3)
 - Toilet tissue dispenser to be mounted within the 24” to 36” zone from the rear wall (ANSI 604.7.1)
 - Outlet or bottom of the dispenser will be at 45” above the finished floor (ADA 604.7)

ACCS INSTRUCTIONS TO ARCHITECTS AND ENGINEERS

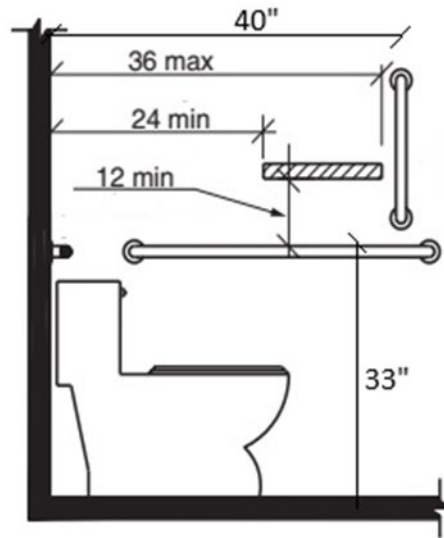

C20: Stairs

C2010: Stair Construction

C2020: Stair Finishes

C30: Interior Finishes

- Details: Architect to design and specify the details for top of the wall finish (i.e. If wainscoting is installed, what is the detail to finish above the wainscot). Architect to detail how floor to door frame will be caulked. Architect to design and specify the details of transitions between the walls and floors (i.e. Wall tile, floor to ceiling, will there be a base) and the walls to ceilings (i.e. Wall tile to drop ceiling grid).

C3010: Wall Finishes

- Paint: All finishes will be specified as Eggshell for walls and Semi-Gloss or Gloss for door casings.
- Restroom Wall Tile: Wall tile in restrooms should not be installed to be flush with the bottom of the ceiling. Newly installed wall tile should end between 6-12 inches before the ceiling and have a clean transition to the sheetrock using metal tile edging. If this is not possible, then the ceiling height should be adjusted to accommodate this standard.

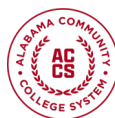

ACCS INSTRUCTIONS TO ARCHITECTS AND ENGINEERS

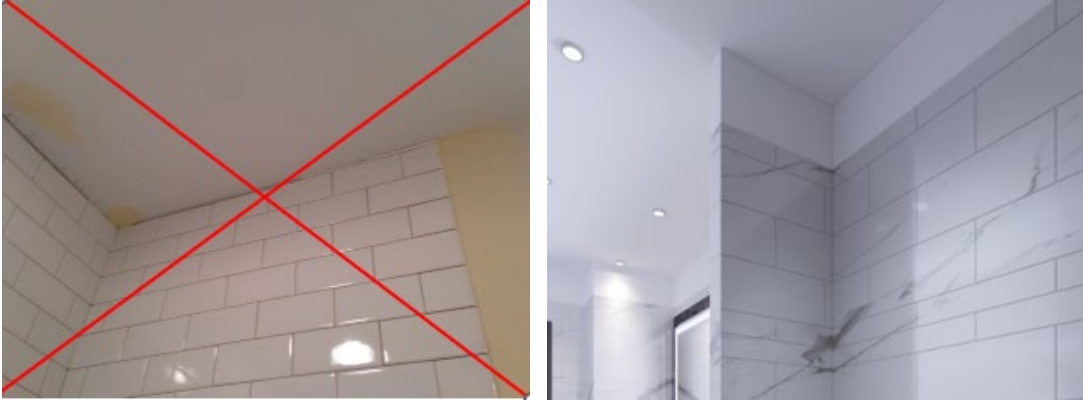

C3020: Floor Finishes

- **Entrance Matting:** Outside all building entrances should be furnished with 10-15 feet of 3M Nomad Scrapper Matting (or equivalent). Inside all building entrances should be furnished with 10-15 feet of Lees Tuff Stuff: First Step, Step in Style and Step Up (or equivalent). These minimum quantities of entrance matting are required, regardless of other floor finishes scheduled for the building. Entrance matting may be used in coordination with a tile or granite border.
- **Carpeting:** All carpet selections, designs, and colors are to be submitted to the Owner for review and approval prior to finalizing bid specifications and construction documents. Color selections should avoid solid patterns and dark colors. Any carpet selected must be equal to Mannington Commercial as the basis of design. If a substitute is desired, then approval must be obtained in writing from ACCS. The College will establish the budget and purchase the carpet for any given project. The owner shall provide a carpet for installation. Contractor is responsible for Owner provided carpet. A qualified contractor will install the carpet. Any carpet that is unused shall be returned to the College.

All carpet tiles are to be oriented and centered within the space, with equal sized tiles, or portion of tiles on either edge of the space. The final layout must be approved by the Owner's Designated Representative prior to installation. All exceptions to centering carpet tile must be discussed with the physical plant project manager and director and obtain written permission to deviate in any way. The contractor shall be responsible for all costs associated with fixing carpet tile to align with this standard if deviated from. This includes, but is not limited to, labor and materials, including carpet tile.

- **Luxury Vinyl Tile (LVT):** All LVT selections, designs and colors are to be submitted to the Owner for review and approval prior to finalizing bid specifications and construction documents. Any LVT selected must be equal to Mannington Commercial as basis of design. No wax shall be applied to LVT.



ACCS INSTRUCTIONS TO ARCHITECTS AND ENGINEERS

- Tile: All tile and grout selections must be submitted to the Owner's Designated Representative for review and approval.
 - All tiles must be sealed within 48 hours of grout installation.
 - Grout Spacing will not be greater than 3/16"
- Workforce Areas: Floor finishes in areas like welding, machine tool, automotive, etc. Pressure wash and clean off floor surface. Apply a concrete densifier. Apply a finish coating of clear sealer.
- Installation: Installation of flooring and wall tile is to be centered on the wall and any joints greater the standard spacing grout size is not acceptable. All corners of tile must be flush and even for final approval. If not accepted it is the contractor's responsibility to make necessary changes. No additional funds will be granted for changes.
- Cove Base: When using vinyl or rubber cove base, factory corners are to be installed.

C3030: Ceiling Finishes

- Ceiling Height: The architect will propose a ceiling height consistent with the function and size of the room and the structural system of the building. Indications on individual room program pages are only preliminary and changes may be necessary.
- Ceiling Tile: Armstrong 1732 Fine Fissured Angled Tegular HumiGard Plus acoustic ceiling tile or equal as approved, shall be used for executive spaces or for areas that require higher finishes. Armstrong 770 Cortega Square Lay-In tiles or equal as approved, shall be used for other spaces. A similar quality of appropriate tile can be used in kitchens, bathrooms, or other similar spaces.
- Suspended Ceiling Grid System: When windows extend above the proposed ceiling height for the suspended ceiling grid, the grid system should not be installed level into the window frame. If the difference in height of the proposed ceiling grid and the top of the window is within 12 inches, the ceiling grid for that wall should slope up to the top of the window, but no more than 30 degrees. If the difference in height is more than 12 inches, install a bulkhead off set from the wall.



ACCS INSTRUCTIONS TO ARCHITECTS AND ENGINEERS

D: SERVICES

Revision History

Section	Summary of Change	Revision Date
D30	HVAC (Mechanical spaces and interior access)	5/17/24
D5030	Communications and Security (Technology and Networking Requirements)	5/17/24
D5090	Other Electrical Systems (Electrical Metering)	5/17/24
D2010	Plumbing Fixtures (Lavatories and Countertops)	10/3/24
D30	HVAC minimum clearance around the equipment	2/10/25
D30	Approved Manufacturers	1/23/26
D3040	Ductwork Insulation	3/10/26
D3050	I-TEC and G-TEC	3/10/26
D2090	Emergency Eye Wash Stations and Showers	5/12/26



ACCS INSTRUCTIONS TO ARCHITECTS AND ENGINEERS

D10: Conveying

D1010: Elevators & Lifts

- Elevators: Elevators will be specified in accordance with ACCS Instructions to Architects and Engineers. In general, elevators will be Hydraulic, unless construction warrants an electric style elevator. Elevator specifications must be approved by an elevator consultant of the owner's choosing.
- Elevator Controls: ACCS requires that any elevator(s) installed as new construction, retrofitted, or updated during renovations shall use one of the following elevator controls.
 - Elevator Controls
 - Motion Control Engineering
 - Virginia Controls
 - No other control system will be accepted by ACCS. If a system is found to not comply with the following the contractor will be required to remove and replace the control system.

ALL parts must be readily available from a distributor in North America.

D1020: Escalators & Moving Walks

D1030: Other Conveying Systems

D20: Plumbing

D2010: Plumbing Fixtures

- Drinking Fountains: Refrigerated drinking fountains will be conveniently located for adults, including the physically disabled in accordance with ADA guidelines. Recommended fixture is the Elkay LZSTL8WSLP or equal. (<https://www.elkay.com/products/details/LZSTL8WSLP>)
- Automated Fixtures: All Automated Faucets and Flushing Products MUST carry a minimum 5-year warranty. All automated fixtures are required to be hard-wired (no batteries). Manual fixtures are acceptable per College request.
 - Zurn, American Standard, and Toto are preferred manufacturers.
- Shower Lifts: All residential lift shower solutions require Owner approval.
- Heating: All Exterior water coolers and fountains are required to have heaters for freezing temperatures. The contractor is responsible for ensuring that heaters are turned on and



ACCS INSTRUCTIONS TO ARCHITECTS AND ENGINEERS

activated before the project is closed out. Heaters must be thermostatically controlled or have automatic response to freezing temperatures.

- Exposed or non-climate-controlled piping for exterior fixtures shall have heat tape applied. Isolation of these fixtures from the main water supply is preferred through use of shut off valves and drains to these exterior fixtures.
- Lavatories and Countertops: No wall hung, or pedestal lavatories will be allowed. All lavatories should be part of a countertop system. Lavatories should be undermount models that are flush with the countertop surface. The below-deck serviceable components shall not be exposed or visible to the public. However, access for maintenance of below-deck components should be simple and able to be done by one person.

Countertops should be solid surface, non-porous, homogenous material with a composition of acrylic polymer, aluminum trihydrate filler and pigment. Solid surface shall meet ANSI, ASTM and E84 standards related to use. Basis of Design: Corian® by Dupont.



D2020: Domestic Water Distribution

- Water Pressure: Design Professional must verify that required water pressure and volume is available for project before project start.

ACCS INSTRUCTIONS TO ARCHITECTS AND ENGINEERS

D2030: Sanitary Waste

D2040: Rain Water Damage

D2090: Other Plumbing Systems

- Plumbing Clean-Outs:
 - All clean-outs shall be visible and accessible without obstructions.
 - All clean-outs shall be identified on as-built drawings.
- Floor Drains:
 - All floor drains shall be required to have a method of trap seal or primer.
 - Mechanical room/utility spaces with floor drains are required to slope to drain. Restrooms, labs, and other areas prone to spills are not required to slope to drain.
 - Floor drains are required where ice makers are installed.
- Emergency Eye Wash Stations and Showers:
 - All emergency eye wash stations and showers shall be plumbed and sloped to a drain.

D30: HVAC

- Authorized Manufacturers: The following HVAC manufacturers are approved by ACCS:
 - Trane
 - Carrier
 - 3rd option to be determined during preliminary design with ACCS approval
- General Mechanical: During the design phase, the architect and engineers will meet with the ACCS to jointly determine the best mechanical systems. Air conditioning and heating will be required in all facilities unless otherwise noted. ACCS requests that architects and engineers recommend energy efficient systems.

In the design of mechanical spaces, forethought of how the spaces and equipment will be maintained and/or replaced in the future is an essential component of the design.

Access to interior mechanical equipment for service and preventive maintenance does not require the use of a portable or fixed ladder. The only exception would be a VAV box. Fixed ship ladders are acceptable. No mechanical equipment that requires annual PM/service allowed above the ceiling grid.

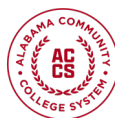

ACCS INSTRUCTIONS TO ARCHITECTS AND ENGINEERS

The minimum clearance around all exterior and interior HVAC equipment is 3 feet. Any exceptions must have ACCS Facilities approval.

- Variable Refrigerant Flow (VRF): VRF systems are not authorized in ACCS buildings without Owner approval.

As part of the design phase architects are required to present a preliminary review of the mechanical yard for review by ACCS.

In addition to the standards established by the Alabama Building Commission, and the 2021 International Mechanical Code, the HVAC systems will be designed in a way that will meet the realities and the needs of the local weather conditions to keep the area comfortable for all who use it.

- Minimum Load and Economizer Operations: HVAC mechanical components and systems must be capable of operating under minimum load conditions where only certain area(s) of a structure may need space conditioned during occupied or unoccupied status. An Economizer option (if applicable) shall be incorporated for cooling during low ambient temperature and low humidity conditions.
- Minimum Load and Economizer Verification Criteria: Controls contractor shall verify the following with ACCS:
 - (A) The designed system will operate effectively under minimal load conditions by initiating a call for cooling and heating for two (2) areas/rooms ONLY (no other devices calling for operation) within a structure and verify that the designed cooling and heating methods and associated components will operate properly for a period of 8 hours without failure, lockout, tripped condition, or alarms of the BAS or equipment.
 - (B) The economizer feature, if applicable, will operate properly when outdoor temperature and humidity level will allow for adequate space conditioning in lieu of other power consuming cooling methods (chillers or other A/C methods). Operation shall be tested by manipulation of system to indicate outdoor temperature of 50 degrees or less and relative humidity of 60 percent or less will turn off primary cooling methods and economizer dampers will modulate/open for cooling. This shall be verified by field observation of cooling devices, viewing the dampers in the economizer, and viewing the BAS graphics.
- Approved Equals: ACCS does not accept York manufactured products or parts as an approved equal. Under no circumstances will York be specified as an approved equal, and a York product will not be considered as an acceptable substitute at any time.

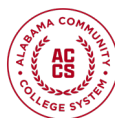

ACCS INSTRUCTIONS TO ARCHITECTS AND ENGINEERS

- Drain Pans: All equipment requiring a drain pan will require a secondary drain pan and be accessible for easy cleaning and maintenance. Equipment drains are preferred to be directed to floor drains.
- Exhaust Fan Motors: All exhaust fan motors will be specified to be installed inside the attic where they can be accessible for maintenance and replacement. This will require that the attic space and access to that space be large enough for the complete replacement of that fan motor.

D3010: Energy Supply

D3020: Heat Generating Systems

D3030: Cooling Generating Systems

D3040: Distribution Systems

- Ductwork Insulation: Exterior Insulation on ductwork shall be installed in accordance with manufacturer recommendations and shall include continuous coverage, vapor barrier jacket, sealed joints, seams, penetrations, and terminations so as to maintain thermal performance and prevent condensation. No internal insulation is allowed without prior approval from ACCS.

D3050: Terminal & Package Units

- I-TEC or Q-TEC: The interior or exterior use of I-TEC or G-TEC products (or similar in nature as to these manufactured by Bard Manufacturing) are prohibited in ACCS buildings without prior ACCS approval. See examples below:

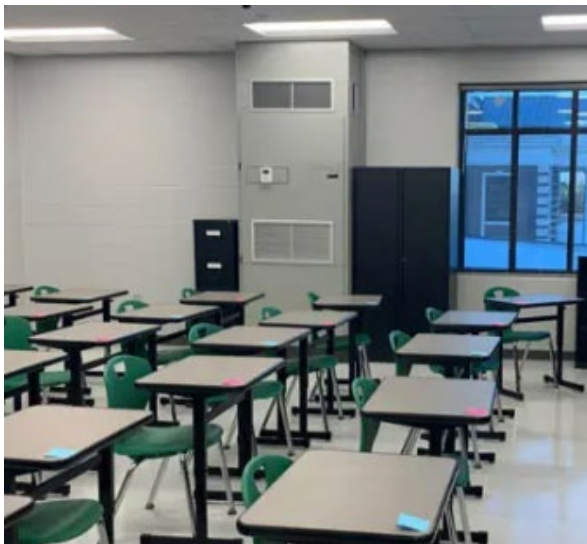

ACCS INSTRUCTIONS TO ARCHITECTS AND ENGINEERS



D3060: Controls & Instrumentation

- Controls:
 - All HVAC systems must have DDC that is compatible with College System.
 - All controls are to be tied back from the project site to the physical plant operation and all controls provide alarm outputs to a monitor.
 - A global set point feature for the individual building shall be programmed, displayed graphically, and adjustable by the end user.
 - BAS Graphics shall allow the end-user the ability to adjust the unoccupied status setpoints. This applies to temperature and humidity values.
 - Programming will be consistent with existing programming methods and graphics currently in use with consideration to the end user and the ability to change graphical and program values from local control.
 - Controls Verification shall be conducted by the Commissioning Authority (CxA), with input from the Controls Contractor and College, and shall include described instructions of Section D30 of this document inclusive of, but not limited to, thermostat and override operation, occupied status functions, unoccupied status functions, CO2 operations, and low load operating conditions. Verification shall be conducted by the CxA that all dampers, valves, etc. open, close, or modulate as specified and that all fans, pumps, etc. energize or de-energize as specified. The CxA shall submit the Commissioning Report with all the final test results to the Engineer for final approval.
 - Calendar/holiday scheduler feature will be programmed so it will ONLY affect the building selected from the menu bar. The calendar scheduling feature WILL NOT be programmed so it affects the entire campus as this does not allow for any flexibility of scheduling building shutdowns during holidays.
 - The General Contractor is expected to document weekly coordination meetings with all subcontractors.



ACCS INSTRUCTIONS TO ARCHITECTS AND ENGINEERS

- The architect of record for the project will be the point of contact for coordinating site visits between the General Contractor and the Commissioning Agent and is required to document all meetings.
- All projects will be bid with instructions to bidders to include an alternate bid for commissioning the facility. A representative from the subcontracting company is required to be present as needed during the commissioning process.
- **Thermostats:** Shall include a simple occupancy override pushbutton for local control during unoccupied status. This will allow the conditioned space system to operate temporarily and shall be programmed for 2 hours of operation.
 - Thermostats shall include humidity sensing capability. If a thermostat with humidity sensing capability is not available, an alternative must be discussed and approved by the College.
 - If applicable: Humidity values must be considered as a priority to override the Unoccupied Status Temperature Set Points.
 - Thermostats and DDC controls shall be password protected.
 - **Thermostat Verification Criteria:**
Controls contractor shall verify the following with the College:
 - (A) Thermostat installed and secured properly.
 - (B) Operation of the button(s) raise and lower set points.
 - (C) Thermostat shows room temperature during normal mode.
 - (D) While HVAC system is in Unoccupied Status, press override button and verify system operates for 2 hours and returns to Unoccupied Status.
 - (E) Verify that thermostat displays accurate room temperature by comparison with a calibrated secondary instrument.
 - (F) During Unoccupied status, if applicable, thermostat(s) with humidity sensor capability shall be exposed to a method of high humidity and verify that the HVAC system(s) will change to Occupied status and operate until humidity set point reached.
 - (G) Current room numbering and desired floor plan for graphics usage.
 - (H) Thermostats will have nameplate installed matching corresponding nameplate of equipment.
 - Occupied Status: Set points will be programmed by the contractor in such a manner that they can be displayed and adjusted graphically. The initial values shall be 70-to-74 degree operating range.
 - **Occupied Status Verification Criteria:**
Controls contractor shall verify the following with the College:
 - (A) Visually represents that the specified set points have been applied.
 - (B) Demonstrate that the set point values can be modified graphically.
 - (C) Demonstrate that cooling operation shall maintain cooling set point lowering cooling set point to 62 degrees and field verify and/or graphically verify that cooling equipment to include, but not limited to (chillers or other cooling methods) function, circulating pumps on, fans on, cooling valves



ACCS INSTRUCTIONS TO ARCHITECTS AND ENGINEERS

modulate, VAV's damper modulation, AHU VFD's establish engineered duct pressures, heating or reheat sources are off (HW reheat valve closed), OA dampers functioning to maintain 1000PPM CO2.

- (D) Demonstrate that heating operation shall maintain heating set point raising heating set point to 80 degrees and field verify and/or graphically verify that heating equipment to include, but not limited to (boilers or other heating methods) function, circulating pumps on, fans on, heating valves modulate, VAV's damper modulation, AHU VFD's establish engineered duct pressures, heating or reheat sources are on (HW reheat valve open), OA dampers functioning to maintain 1000PPM CO2.
- Unoccupied Status: Set points will be programmed by the contractor in such a manner that they can be displayed and adjusted graphically. The values shall be 60 degrees for heating and 78 degrees for cooling.
- Unoccupied Status Verification Criteria:
Controls contractor shall verify the following with the College:
 - (A) Visually represents that the specified set points have been applied.
 - (B) Demonstrate that the set point values can be modified graphically.
 - (C) A value of 55 degrees will be overwritten to the program and verify that the heating system or heating methods will switch to Occupy status and operate until Unoccupied set point is satisfied, then return to Unoccupied status. Likewise, a value of 80 degrees will be overwritten to the program and verify that the cooling system or cooling methods will switch to Occupy status and operate until the set point satisfied and then return to Unoccupied status.
- CO2 Sensors:
 - Systems using Air Handler Units ONLY:
Conditioned space control shall incorporate a Carbon Monoxide (CO2) sensor in the return duct. The BAS shall calculate outdoor Air (OA) supply to maintain 1000PPM CO2 set point during occupied status for the zone in which the AHU serves. OA dampers shall be set to achieve 100% closure during unoccupied settings.
 - Systems using Air Handler Units and VAV's:
Conditioned space control shall incorporate Carbon Monoxide (CO2) sensors accordingly. The BAS shall calculate outdoor Air (OA) supply to maintain 1000PPM CO2 set point during occupied status for the zone in which the VAV's are serving. OA dampers for AHU's shall be set to achieve 100% closure during unoccupied settings.
 - CO2 Verification Criteria:
Controls contractor shall verify the following with the College:
 - (A) When HVAC system is in Unoccupied mode, open air handler unit access door to access the OA dampers and verify if dampers are 100 percent closed. Minimum OA dampers will be 100 percent closed during Unoccupied status.

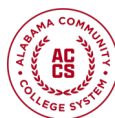

ACCS INSTRUCTIONS TO ARCHITECTS AND ENGINEERS

- (B) CO2 operation shall be tested by manipulation of system to indicate 2000 PPM and monitor operation of the OA dampers to open for reduction of CO2 and/or exhaust methods are operation, if applicable for balance.
- (C) CO2 operation shall be tested by manipulation of system to indicate 400 PPM and monitor operation of the OA dampers for closure and RA damper is 100 percent open. The minimum OA damper should be 10 percent open or as specified for air control quality standards and balance.
- (D) Return air dampers, minimum OA dampers, exhaust dampers/fans shall be visually verified to operate accordingly in respect to OA damper position and building balance requirements.

D3070: Systems Testing & Balancing

- Test and Balancing: Shall be included in the budget and bid of project. The awarded test and balance company must be independent of building contractors. All reports will be submitted to the owner at the end of inspection. The owner will hold a joint meeting with GC and all contractors involved to resolve any lingering issues.

D3090: Other HVAC Systems & Equipment

- Filters: All new HVAC equipment that will incorporate filters must use industry standard size filters that are readily available and do not have to be fabricated.

D40: Fire Protection

D4010: Sprinklers

D4020: Standpipes

D4030: Fire Protection Specialties

- Fire Detection and Alarm Systems: Fire alarms shall be provided with monitoring capabilities. Panels shall be capable of being connected to a central network at a future date. The only acceptable manufacturers will be non-proprietary systems which are compatible and capable of communicating with additional panels on site. This is limited to Silent Knight, Fire-Lite and Edwards. All new fire alarms shall be addressable. The contractor is responsible for programming the addressable system and all installed devices to reflect the correct location (per?) the College's room numbering system. Fire alarm cabling must be installed neatly and will not rest on light fixtures, ceiling grid, or fire suppression piping. Annunciator panels shall be installed at the primary entry point of the



ACCS INSTRUCTIONS TO ARCHITECTS AND ENGINEERS

building, if the main FACP is in a secure area not accessible to the occupants/emergency responders.

D4090: Other Fire Protection Systems

D50: Electrical

- General Electrical: During the design phase, the architect and engineers will meet with ACCS to jointly determine the best electrical systems. ACCS requests that architects and engineers recommend energy efficient systems. Each electrical panel should contain several unused spots to allow for future expansion.

D5010: Electrical Service & Distribution

- Emergency Power: In addition to whatever emergency lighting may be necessary if the main power is off, emergency power may be required. If a generator is to be included in the project, all emergency lighting and exit lights will be connected to the generator through emergency circuitry. The elevator will also be tied into the generator for emergency backup.

D5020: Lighting and Branch Wiring

- Lighting: Lighting must be energy efficient and attractive. All interior and exterior lighting shall be LED fixtures.
 - Interior lighting shall have a luminescence between 3500K - 4000K.
 - Exterior lighting shall have a luminescence between 4000K - 5000K.
- Lumen maintenance: All light bulbs must maintain 80 percent of the initial light output at 40 percent of their rated lifetime. This means that after 3,200 hours of use, an 8,000-hour CFL still needs to give off 80 percent of the light it gave off during its first 100 hours of operation.
- Daylighting: Architects shall incorporate daylighting as a means of light in new facilities. Daylighting should be incorporated in a way that maximizes energy savings using daylighting technologies, light shelves, windows, etc. The use of daylighting shall be designed to maximize building efficiency with all other mechanical and electrical systems. Where daylighting is implemented, solenoids and other light control technology must be implemented to turn on lighting systems after the natural lighting decreases below the code required levels.
- Exterior Lighting: Architect/ Engineer shall specify exterior light shall be controlled by a photocell. Time clocks will not be acceptable technology.



ACCS INSTRUCTIONS TO ARCHITECTS AND ENGINEERS

- All lighting exterior lighting for each facility shall be controlled by one single photocell that is easily accessible with a step ladder.
- Where the lighting load exceeds more than ½ of the photocell capacity a lighting contactor shall be used as the means to operate the photocell.
- A weatherproof Hand/Off/Auto switch shall be included in the system and shall be enclosed in a lockable box, either in the same box as the lighting contactor or separately.
- The Hand/Off/Auto switch shall be in the immediate vicinity of the lighting contactor and photocell.

D5030: Communication & Security

- General Security: Architects and Engineers will design all projects to include security systems in drawings and specifications as part of the base bid. Specifications will require the awarded contractor to coordinate such installations and provide shop drawings for all security components and locations to be approved prior to purchase and installation of equipment.
- Access Control and Security Systems: Architects and Engineers will schedule a meeting with the College to review project and establish needs.
 - Key Security Box: Architect will specify awarded contractor to install a “Key System 8 SAM,” 6” d x 18” w x 18”h, box in all projects. (<http://www.keystorage.com/electroniccabinets.htm>). Key box will include College “FOB” mounted to cabinet, required data cabling and software. Contact Owner’s Designated Representative with questions.
- Audio, Video and Computer Systems: Architects and Engineers will schedule a meeting with the College to review projects and establish needs.

Technology Requirements	
Room Description	Technology Summary
Conference/Meeting Room	All features except Height Adjustable Lectern (substituted with Equipment Rack).
Standard Classroom	All features.
Large Standard Classroom	All features plus in-room instructor voice reinforcement.
Auditorium and Lecture Hall	All features plus in-room instructor voice reinforcement and auxiliary equipment suitable for large spaces and third-party use.

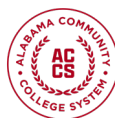

ACCS INSTRUCTIONS TO ARCHITECTS AND ENGINEERS

Technology	Requirements
Accessibility	
Height Adjustable Lectern	ADA compliant, accommodates wheelchairs.
Assisted Listening Technology	Available through the ADA office.
Content Presentation	
Standard Lectern PC with Webcam	Autologin for local content display. Login to Zoom/Teams for remote/hybrid meeting/class.
PowerPoint Clicker	Wireless PowerPoint control.
Document Camera	Share pre-printed written material. Share live annotation from any writable surface (paper, dry/erase board, tablet, etc.).
Projector(s)/TV Display(s)	More than one projector or display panel may be present depending on the layout of the room. Display Panel may be touch screen.
Large Whiteboard(s)/Projection Screen(s)	More than one projection surface may be present depending on the layout of the room. Projection screens to be permanent and motorized.
Wireless Presentation - AirMedia	Wirelessly share content from a laptop or device.
Auxiliary HDMI inputs	Share content from a connected laptop or device.
Audio (In-Room Microphone & Speakers)	
Audio System with Ceiling Speakers	In-room students can hear remote students. In Large Standard Classroom and Auditoriums, in-room students can hear microphones. Remote students can hear microphones.
Microphones	Wireless Lapel Microphone. Lectern Gooseneck Microphone. Ceiling Microphones for Student coverage.
10" Touch Panel for Room Automation (or other Campus specific standard)	Adjustable speaker volume. Adjustable microphone volume. Switch inputs. Automatic power-down when room is unoccupied.

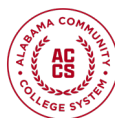

ACCS INSTRUCTIONS TO ARCHITECTS AND ENGINEERS

Technology	Requirements
Accessibility	
Height Adjustable Lectern	ADA compliant, accommodates wheelchairs.
Assisted Listening Technology	Available through the ADA office.
Content Presentation	
Standard Lectern PC with Webcam	Autologin for local content display. Login to Zoom/Teams for remote/hybrid meeting/class.
PowerPoint Clicker	Wireless PowerPoint control.
Document Camera	Share pre-printed written material. Share live annotation from any writable surface (paper, dry/erase board, tablet, etc.).
Projector(s)/TV Display(s)	More than one projector or display panel may be present depending on the layout of the room. Display Panel may be touch screen.
Large Whiteboard(s)/Projection Screen(s)	More than one projection surface may be present depending on the layout of the room. Projection screens to be permanent and motorized.
Wireless Presentation - AirMedia	Wirelessly share content from a laptop or device.
Auxiliary HDMI inputs	Share content from a connected laptop or device.
Audio (In-Room Microphone & Speakers)	
Audio System with Ceiling Speakers	In-room students can hear remote students. In Large Standard Classroom and Auditoriums, in-room students can hear microphones. Remote students can hear microphones.
Microphones	Wireless Lapel Microphone. Lectern Gooseneck Microphone. Ceiling Microphones for Student coverage.
10" Touch Panel for Room Automation (or other Campus specific standard)	Adjustable speaker volume. Adjustable microphone volume. Switch inputs. Automatic power-down when room is unoccupied.
Hybrid Classes and Lecture Capture	
Live Stream (Zoom/Teams)	Remote students can see video, projected content, and hear audio from microphones.



ACCS INSTRUCTIONS TO ARCHITECTS AND ENGINEERS

Recording (Kaltura & Zoom/Teams)	Record hybrid classes with Zoom/Teams, and traditional classes with Kaltura.
Instructor Ceiling Microphones for Live Stream and Recording	Audio is fed to the lectern PC for capture by Zoom/Teams and Kaltura.
Whiteboard Capture	Capture the Physical whiteboard with the PTZ camera. Use the document camera to share annotation. Use the Windows or Zoom whiteboard feature on the lectern PC.
Lecture Capture PTZ Tracking Camera	Defaults to auto tracking of the instructor. Use presets on the touch panel to focus on the lectern, wide angle of the front of the classroom, or other areas custom to each room. Use the touch panel to manually control the zoom and direction of the camera.
Webcam on Lectern PC	This is an option depending on instructor preference. Can be used as back up to the PTZ camera and microphones.
Large Space Accommodation (Auditorium or Lecture Hall, for example)	
Auxiliary AV Inputs and Outputs for Large Events and Press Access	Available: exact configuration varies by room.
Multiple Projectors and/or Displays	View content or video from different vantage points.
Advanced AV Routing and Control	Available for advanced users.
Requirements	
Power	One 120V 15A outlet/junction box (as appropriate) at Lectern/Equipment Rack, Projector, Projector Screen, and Display.
Data	Four PoE+ (or better) Capable Ports on Wall plate at Lectern/Equipment Rack.
AV Pathways	One 4 inch or two 2 inch paths/conduits (as appropriate) from Lectern/Equipment Rack to each Projector, Projector Screen, and Display. One 2-Gang Low-Voltage Bracket per Path.



ACCS INSTRUCTIONS TO ARCHITECTS AND ENGINEERS

Network Requirements	
Room Description	Requirements
Main Distribution Frame (MDF)/Data Center	Dedicated cooling with redundancy
	Generator and UPS backup
	Drop ceiling
	Minimum Quantity (4) 5-20R outlets on separate circuits behind or above racks
	Minimum Quantity (2) L5-30R or L6-30R as appropriate outlet behind or above racks
	Full Height 4 post data rack (or row of racks if # of drops dictate) and at least 4 feet clearance on each side of rack or row of racks
	Vertical and Horizontal wire management and patch panels
	Wood Backboard on at least one wall
	Minimum (2) 4" and (2) 2" entry conduits from service provider demarc (if MDF is the demarc for the campus)
	Minimum (2) 2" conduit to facilitate campus fiber connections (if appropriate)
Ladder/cable tray as appropriate between racks and backboard	
Intermediate Distribution Frame (IDF)	Dedicated cooling
	Drop ceiling
	Minimum Quantity (2) 5-20R outlets on separate circuits behind or above racks
	Minimum Quantity (1) L5-30R or L6-30R as appropriate outlet behind or above racks
	Full Height 4 post data rack (or row of racks if # of drops dictate) and at least 4 feet clearance on each side of rack or row of racks
	Vertical and Horizontal wire management and patch panels
Office	Minimum of (4) (2 duplex) network drops with Cat6 spread over two walls of the office
Classroom	Minimum 2-4 network drops at teaching stations for each classroom
Lab	Pathways for network drops in floor or wall to allow for a common or frequent lab configuration determined by IT and the associated instructional department at the institution
Flex Spaces	Pathways for network drops in both floor and wall where possible for multiple teaching configurations. Also allow for a pathway(s) for sufficient wireless APs to support increased flex technology depending on classroom size and max headcount.

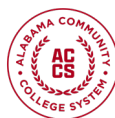

ACCS INSTRUCTIONS TO ARCHITECTS AND ENGINEERS

Equipment	Requirements
Network Switch	Managed switch with PoE and enough uplinks for future expansion. Switch to be located in a secure enclosure in a centralized (IDF) location. I.E. no switches located outside of IDF
Access Point	WiFi 6/e with a 5Gbps uplink recommended
Fiber	Single mode OS2 underground in conduit (minimum 2") for building-to-building connectivity 12 strand minimum. Fiber should be housed in Innerduct within the main conduit to allow for future use of conduit. Pull boxes should be installed to provide for future campus expansion.
	Single mode OS2 fiber run through Innerduct should be utilized to connect MDF to IDF's.
	OM3/4 for connectivity within the data center
Cable Tray	Wire basket tray. Also, using fire stops for wires going through fire rated walls.
Copper Cable	A campus standard should be established for data wire and termination products and used in all wiring projects. This will allow selection of installers that are certified and standardization of tools used by campus technicians. (We recommend using Berk-Tek wire with Leviton jacks and patch panels or Hubbell for everything) The standard should be specified prior to the project according to the local IT standards.

- Closed Circuit TV: Architects and Engineers will Schedule a meeting with the College to review project and establish needs.
- Telephone and Data Lines: Architect and engineers will meet with the College IT department during the design phase to determine and approve all outlet locations and requirements. The contractor will furnish and install conduit and boxes. All cables, terminals, jacks, speakers, and related equipment shall be installed in a neat and orderly manner. Multiple cables shall be neatly bundled and tied to approved attachments points. No cable shall be attached to, resting on, or otherwise touching the fire sprinkler pipes, ceiling, ceiling grid, conduits, or support components of these systems.
- Security Systems: Locks will not be keyed "off the master" and alarm systems in general will not be allowed. For areas that require additional security, magnetic locking systems and/or security cameras may be approved. Contact Owner's Designated Representative to review project and discuss needs.



ACCS INSTRUCTIONS TO ARCHITECTS AND ENGINEERS

- Communication Rooms: Communication rooms will be provided in the building design to accommodate voice/data communications MDF and IDF terminals and equipment. These rooms are to come from non-assignable sq ft. Power required is 120 volts.

The communication rooms will be dedicated to building communications only. Communication rooms will not contain high voltage transformers and/or power panels. Communication room walls will be reinforced material to accommodate the weight of terminals and other wall mounted equipment. The building design will provide for a communication room on every floor.

Communication rooms will be located such that wiring to any jack served by this room will not exceed 90 meters (295 feet) in length. When building design allows, communication rooms will be stacked.

D5090: Other Electrical Systems

- Clocks: Clocks will be provided in classrooms and common spaces. Clocks shall be electric and must be hard wired or plugged in. Power supply for clocks shall be provided behind each clock location. Battery powered clocks will not be allowed.
- Vending Machines: An area should be provided for vending machines. The Owner will approve the number of machines and placement. If machines are to be placed in a hallway, they must be placed in an alcove, so the machines do not restrict egress. This area could be an alcove in a hallway. Sufficient power should be provided.
- Electrical Metering: All new construction and major renovation shall include an electrical metering system. Electrical contractors shall be responsible for purchasing and installing the chosen metering system on all new construction or major renovation projects if not already provided by the local jurisdiction. The metering system should be consistent with what the College is currently using. Preference would be for a smart metering option that does not require the meter to be connected to the network. Architects shall designate an allowance for this system.



ACCS INSTRUCTIONS TO ARCHITECTS AND ENGINEERS

E: EQUIPMENT & FURNISHINGS

Revision History

Section	Summary of Change	Revision Date
E2010	Countertops (no laminate)	5/17/24
E2010	Window Treatments (no electric or motorized treatments)	10/3/24

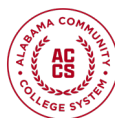

ACCS INSTRUCTIONS TO ARCHITECTS AND ENGINEERS

E10: Equipment

E1010: Commercial Equipment

E1020: Institutional Equipment

E1030: Vehicular Equipment

- **Loading Dock:** If this building will be provided with a loading dock, it must be unobtrusively located near a service entrance and accessible to an elevator. Permanently installed dock levelers are desired.

E1090: Other Equipment

E20: Furnishings

E2010: Fixed Furnishings

- **Building Directories:** Building directories with space for names of staff and faculty, and space for floor plans will be installed at prominent locations near entrances to the building and near stairways on each floor. These directories will be furnished by the owner.
- **Bulletin Boards/Chalk Boards/White Boards:** Bulletin boards, chalk boards and white boards should be durable high-quality products. White boards should be porcelain enamel steel with aluminum frames and marker trays. Chalk boards should be vitracite porcelain enamel steel with aluminum frames and chalk trays. Bulletin boards should be high quality vinyl equal to Claridge's Fabricork with aluminum frames.
- **Countertops:** No laminate on countertops except by ACCS exception.
- **Display Cases:** Display casing may be required in the public areas of the building. The architect is free to suggest locations. These display cases are to be used for instructional purposes.
- **Mailboxes:** All mailboxes will be built with lock cylinders ready to accept College cores.
- **Signage:** All signage must be approved by the owner. Interior room numbering signage will be installed by the contractor. The owner will install exterior signage. If approved, lettering on the exterior of the building will be furnished and installed by the contractor.



ACCS INSTRUCTIONS TO ARCHITECTS AND ENGINEERS

- Window Treatments: All buildings must include window treatments as part of the base design and at a minimum be included in the specifications for the base bid. This includes all shutters, blinds, screens, or curtains. Windows can be excluded only if they are designated as lights to an entry door or otherwise part of the entry. Interior windows that are not part of an entry are not to be excluded from this requirement. The architect will make requests for exceptions accordingly, and this will be documented.

No electric or motorized window treatments without ACCS approval.

E2020: Movable Furnishings

- Furnishings: The architect is free to recommend furnishings; however, the owner must approve all changes. Recommended alternates will be considered if the architect can show that the product is equal to or better than what is specified.



ACCS INSTRUCTIONS TO ARCHITECTS AND ENGINEERS

F: SPECIAL CONSTRUCTION & DEMOLITION

Revision History

Section	Summary of Change	Revision Date
F2020	Hazardous Materials Assessment	5/17/24



ACCS INSTRUCTIONS TO ARCHITECTS AND ENGINEERS

F10: Special Construction

F1010: Special Structures

F1020: Integrated Construction

F1030: Special Construction Systems

F1040: Special Facilities

F1050: Special Controls and Instrumentation

F20: Selective Building Demolition

F2010: Building Elements Demolition

F2020: Hazardous Components Abatement

- Hazardous Materials Assessment: For buildings built prior to 1990, 3rd party tests and surveys to ascertain the presence of hazardous materials should be completed before moving into preliminary design phase so that an abatement specification can be provided in the bid documents.



ACCS INSTRUCTIONS TO ARCHITECTS AND ENGINEERS

G: BUILDING SITEWORK

Revision History

Section	Summary of Change	Revision Date
G2040	Campus Entry Concept	10/3/24
G2040	No vinyl fences	2/10/25
G2050	Landscape – Sod	5/15/25
G2010	CDL Training Roadways and Pad	5/12/26



ACCS INSTRUCTIONS TO ARCHITECTS AND ENGINEERS

G10: Site Preparation

G1010: Site Clearing

G1020: Site Demolition and Relocations

G1030: Site Earthwork

- Erosion Control Plan: Architect is responsible to provide comprehensive erosion control plan that complies with standards and regulation set by state and local authorities having jurisdiction. It is the responsibility of the architect to monitor all activities with the awarded contractor to ensure minimal disturbance to the environment.

G1040: Hazardous Waste Remediation

G20: Site Improvements

G2010: Roadways

- Roadways: Will be paved in a way that the joints between pulls will be seamless.
- CDL Training Roadways and Pad: Check with ACCS on any requirements needed for CDL.

G2020: Parking Lots

G2030: Pedestrian Paving

- Walkways: Will be designed of sufficient strength for light vehicular traffic. Sidewalks will be at least 8 feet wide.
- Handrails: Handrails shall be made from galvanized steel. All anchor holes to the post of handrails shall be filled with concrete and provide positive drainage of water away from rail.

G2040: Site Development

- Chain link: No fences shall be chain link.
- Wood: No fences shall be wood.
- Vinyl: No fences shall be vinyl.



ACCS INSTRUCTIONS TO ARCHITECTS AND ENGINEERS

- Campus Entry Concept: New and renovated campus entrances should adopt the concept of a landscaped portal entry, with monument signage on both sides of the entrance and one side of entry with the standard three flag poles. Sidewalks and crosswalks should be incorporated where applicable. Sample design below:



G2050: Landscaping

- General Landscaping: All landscaping additions and changes will be furnished and installed as part of the contractor's contract. The owner must approve the design.
- Irrigation Sprinklers: All designs and specifications will require the review and approval of the Owner's Designated Representative prior to finalizing bid specifications for contractors, and will include head-to-head coverage, the use of Rain Bird (or equal) heads and valves, and rain sensors. All sprinkler systems will be furnished and installed by the contractor.
- Irrigation Installation:
 - Only silicone wire nuts will be approved.
 - Trenches for irrigation lines are to remain open until all irrigation is tested for leaks. Contractors will be responsible for all costs to repair leaks, landscaping, hardscape, etc. if this is not completed prior to burying the lines. Contractors are to contact the Owner for the required testing methods.
 - A separate O&M binder shall be required on each project for irrigation systems. Irrigation plan drawings shall be provided in O&M binder (this is in addition to the required as-built drawings at Close-Out).
 - An initial O&M irrigation training is to be conducted by the contractor or their authorized vendor. A one month, and six months retraining, and review will be

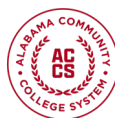

ACCS INSTRUCTIONS TO ARCHITECTS AND ENGINEERS

required by the contractor or their authorized vendor to ensure the system is functioning properly and fully operational.

- Irrigation System
 - Manually controlled underground irrigation system, with low point self-drain.
 - Low Voltage Controls: 24 volts, A.
 - Manufacturers:
 - Rain Bird Sales, Inc: www.rainbird.com.
 - Materials
 - Pipe: PVC Pipe ASTM D2241; 200 psi (1.38 MPa) pressure rated upstream from controls; 160 psi (1.10 MPa) downstream; solvent welded sockets.
 - Fittings: Type and style of connection to match pipe.
 - Solvent Cement: ASTM D 2564 for PVC pipe and fittings.
 - Sleeve Material: PVC
 - Outlets
 - Rotary Type Sprinkler Head: Pop-up type with screens; fully adjustable for flow and pressure; size as indicated; with letter or symbol designating degree of arc and arrow indicating center of spray pattern.
 - Spray Type Sprinkler Head: Pop-up head with full circle pattern.
 - Valves
 - Gate Valves: Bronze construction non-rising stem. Only commercial grade valves are to be used.
 - Backflow Preventers: Iron body construction, double check valve type.
 - Valve Box and Cover: All valve box covers are to be detected by metal detector.
 - Drain Valve: Only commercial grade valves are to be used.
- Controller: Automatic controller, microprocessor solid state control with visible readout display, temporary override feature to bypass cycle for inclement weather, timer for a 4-station system, programmable for 7 days in quarter hour increments, with automatic start and shutdown.
 - Grounded per specifications.
 - Only commercial grade decoders are to be used.
 - All decoders are to be labeled.
 - The cost for IQ technology shall be quoted along with a traditional set up that can be upgraded. The owner will make the decision as to what box will be used. Equipment to be included, but not limited to, shall include:
 - Rain sensor
 - Flow sensor
 - Surge protection



ACCS INSTRUCTIONS TO ARCHITECTS AND ENGINEERS

- Controller Housing: NEMA 250 Type 3; weatherproof, watertight, with lockable access door.
 - Grounded per specifications.
 - The control box must have IQ technology or equal and must comply with (1) year service agreement.

- Valves: Hydraulic; normally open; hydraulic tubing, including required fittings and accessories.
 - Only commercial grade valves are to be used.

- Wires: All wires are to be tagged.
 - A minimum of 3 feet of additional wire above ground is to be coiled at each splice along the two-wire path. All splices are to be labeled.
 - E. Wire Conductors: Color coded
 - All plantings and landscape designs, whether specifically commissioned by the College, or included by the architectural firm as part of the overall building design package, require review and approval by the Owner prior to proceeding with the landscaping design. The company responsible for the designs shall be responsible for all costs in bringing the designs to the College specifications, if approval has not been granted. This includes but is not limited to, cost of redesigning, or replacement of fixtures, hardscape, softscape, etc. that have been placed on site.

- Sod: Provide sod in rolls, not slabs, not less than 2 years old and free of weeds and undesirable native grasses. Only provide sod capable of growth and development when planted (viable, not dormant). Provide machine cut sod of a uniform minimum soil thickness of 5/8 inch, plus thickness of top growth and thatch. Sod pieces to be consistent in size and shape. The sod shall not be over-seeded and must be laid within 48 hours of delivery. If the project involves sod installation, a discussion on an irrigation solution should happen in the design phase. A Pre-Landscape Sod Installation meeting should happen before any sod is installed.

- Flower Beds: Flower beds will be designed around the immediate perimeter of the structure.

- Tree & Shrub Location: Trees and shrubs will be considered in use for screening or hiding exterior electrical/mechanical equipment where code allows.

- Bollards: Bollards must be painted black or Owner approved.

- Exterior Furnishings: Bicycle racks, benches and trash receptacles should closely match the standard that is on the College campus.



ACCS INSTRUCTIONS TO ARCHITECTS AND ENGINEERS

G30: Site Mechanical Utilities

G3010: Water Supply

G3020: Sanitary Sewer

G3030: Storm Sewer

G3040: Heating Distribution

G3050: Cooling Distribution

G3060: Fuel Distribution

G3090: Other Site Mechanical Utilities

G40: Site Electrical Utilities

G4010: Electrical Distribution

G4020: Site Lighting

G4030: Site Communications & Security

G4090: Other Site Electrical Utilities

G90: Other Site Constructions

G9010: Service and Pedestrian Tunnels

G9090: Other Site Systems & Equipment

ACCS INSTRUCTIONS TO ARCHITECTS AND ENGINEERS

APPENDIX A – FORMS

APPENDIX B – SUPPORTING DOCUMENTS

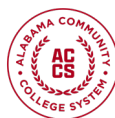

ACCS INSTRUCTIONS TO ARCHITECTS AND ENGINEERS

SPACE NAMING GUIDELINES

TABLE OF CONTENTS

1. Introduction
 - 1.1 General
 - 1.2 Definitions
2. College, Campus, Building, Room Codes
3. Floor Numbering
 - 3.1 Floors
 - 3.2 Basements
 - 3.3 Mezzanines
 - 3.4 Attics and Roofs
4. Room Numbering
 - 4.1 Buildings with One Main Corridor
 - 4.2 Buildings with Multiple Corridors
 - 4.3 Skip Numbers to Maintain Succession and for Future Renovation
 - 4.4 Suites
 - 4.5 Accessible Spaces
 - 4.6 Non-Assignable Spaces
 - 4.7 Positioning within a Building
5. Conflicts and Review



ACCS INSTRUCTIONS TO ARCHITECTS AND ENGINEERS

1. INTRODUCTION

The purpose of this document is to define the Alabama Community College System's Space Numbering Guidelines for standardizing floor and room numbers. The Space Numbering Guidelines shall be utilized to insure continuity and to help maintain integrity throughout the Alabama Community College System (ACCS). This document will be updated periodically; therefore, it is essential that design professionals use the most current version.

1.1 GENERAL

The Space Numbering Guidelines reflect industry standards. It is not intended to be all-inclusive. These guidelines will allow floor and room numbering and way-finding procedures to be consistently applied to all Alabama Community College System facilities. For new buildings, these guidelines shall be followed as closely as possible, with exceptions only by approval from ACCS Facilities Division. Existing ACCS College facilities will also be evaluated against these guidelines when renovations or additions take place.

The intention is for each facility's floor and room numbering scheme to be structured so that the numbers flow through the building in a consistent, comprehensible, and user-friendly pattern. The scheme should be clear and obvious to users and visitors to the facility. Emergency responders rely on our system room numbers to assist in wayfinding during an emergency. Multiple databases rely on room numbers and therefore they should not be changed without a formal review process by the ACCS Facilities Division.

1.2 DEFINITIONS

Attic is the space just below the roof of a building. This is an accessible area above the top floor which is greater than 3 feet in height.

Bridges are covered and walled connecting passageways for people to pass over to gain access to another facility.

Building Service Areas are non-assignable spaces used to support its cleaning and public hygiene functions.

Central Utility Plant is a facility that primarily houses central utility production and/or distribution to more than one facility on campus.

Circulation Areas are non-assignable spaces required for physical access to floors or subdivisions of space within the building, whether directly bounded by partitions or not.

Closets are numbered according to the room they are attached to using an alphabetic designation.

Corridors/Hallways are defined as circulation areas accessible to the public.

Custodial Rooms are any number of rooms and spaces for use by the custodial staff not accessible to the public.



ACCS INSTRUCTIONS TO ARCHITECTS AND ENGINEERS

Elevator is a platform or compartment housed in a shaft for raising and lowering to different floors.

Escalator is a moving passageway that carries passengers from one floor level to another or along a level path for some distance.

Loading Dock is a covered area of a platform used to load or unload goods or materials within a reasonable time such that the platform is not considered a storage location.

Lobbies are considered halls, foyers or waiting rooms at or near the entrance to a building that is not enclosed.

Main Floor is the first level at or above grade, or half a flight up if the door entrance is between floors from the official address side of the building.

Mechanical/Utility Spaces are building service rooms with one or more utility and/or mechanical functions for the building not accessible to the public.

Mezzanine an intermediate level between floors and not used for general circulation or accessible to the public.

Non-Assignable Area is an area not available for assignment to an occupant or for specific use, but necessary for the general operation of a building (Building Service, Circulation, Mechanical).

Restrooms are rooms, locked or unlocked, having a sink, toilet, and other facilities for use by the general public.

Roof is the structure forming the upper exterior covering of a building.

Shafts are either accessible or non-accessible spaces available to house utility pipes and cables or distribute air within or to the exterior of the building.

Stairways that are inside the building are given a number for identification.

Storage/Supply Rooms are rooms designated for the storage of supplies, materials, and equipment not accessible to the public.

Suites are a series of attached rooms with a primary room that has entrance from a corridor.

Tunnels are covered and walled connecting passageways for people to pass under the ground to gain access to another facility.

2. COLLEGE, CAMPUS, BUILDING, ROOM CODES

There is a need to have a standardized coding system for the Colleges, Campuses, Buildings and Rooms. Codes can be used in place of real names or common names in programming to be more efficient and productive. Integrating different software systems using these same codes allows the programs to work together seamlessly.

To be in alignment now and with future software integrations, the following code standards will be used:

College – up to 6 alphanumeric characters

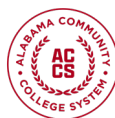

ACCS INSTRUCTIONS TO ARCHITECTS AND ENGINEERS

Campus – up to 3 alphanumeric characters

Building – up to 6 alphanumeric characters

Room – up to 10 alphanumeric characters

A chart of the established codes for the different colleges in the Alabama Community College System is provided below as an example in *Figure 2A*.

<i>Name of College/Institution</i>	<i>VPDI Code</i>
ACCS System Office	ACCSO
Alabama Technology Network	ATN
Bishop State Community College	BISHOP
Bevill State Community College	BSCC
Central Alabama Community College	CACC
Calhoun Community College	CCC
Coastal Alabama Community College	COASTL
Chattahoochee Valley Community College	CVCC
J. F. Drake State Community & Technical College	DRAKE
Enterprise State Community College	ESCC
Gadsden State Community College	GSCC
J. F. Ingram State Technical College	ISTC
Jefferson State Community College	JSCC
T. A. Lawson State Community College	LAWSON
Lurleen B. Wallace Community College	LBWCC
Marion Military Institute	MMI
Northeast Alabama Community College	NACC
Northwest Shoals Community College	NWSCC
Reid State Community College	RSTC
Snead State Community College	SNEAD
Shelton State Community College	SSCC
Southern Union State Community College	SUSCC
H. Council Trenholm State Community College	TSCC
George C. Wallace Community College	WCC
George Corley Wallace State Community College	WCCS
Wallace State Community College	WSCC

Figure 2A

3. FLOOR NUMBERING



ACCS INSTRUCTIONS TO ARCHITECTS AND ENGINEERS

The first character of a room number indicates the floor level of the building. Level “1” should be the uppermost floor entered at grade or one-half flight above grade. The levels below this shall use “B” for Basement. Buildings located on severely sloped sites may need to vary from this rule, where necessary. See *Figure 3A*.

3.1 FLOORS

Floors will be numbered with a 1-digit standard starting with ‘1’ for the first floor and continuing up for every floor above. When a building has more than 9 floors above grade, a 2-digit number will be used (e.g., 2 = second floor, 3 = third floor, 11 = eleventh floor).

3.2 BASEMENTS

Floors below grade or below the first floor are to be designated as basements. These floors will begin with floor B1 and continue downward as B2, B3, etc.

3.3 MEZZANINES

A mezzanine is defined as a partial floor between two floors. Mezzanines will use a 2-character code with the prefix “MZ”, followed by the number of the floor which is directly below. For example, if the mezzanine is between the second and third floors of a building, the mezzanine would be designated as floor “MZ2”.

3.4 ATTICS and ROOFS

Attics will use a 2-character code with the prefix “AT”, followed by the number of the floor that comes sequentially after the uppermost floor accessible to the public. For example, if the uppermost accessible floor is the 4th floor, the attic floor will be labeled “AT5”.

Roofs will also use a 2-character code with the prefix “RF”, followed by the number of the floor that comes sequentially after the uppermost floor accessible to the public or the attic. For example, if the roof level were just above AT5, it would be labeled “RF6”.



ACCS INSTRUCTIONS TO ARCHITECTS AND ENGINEERS

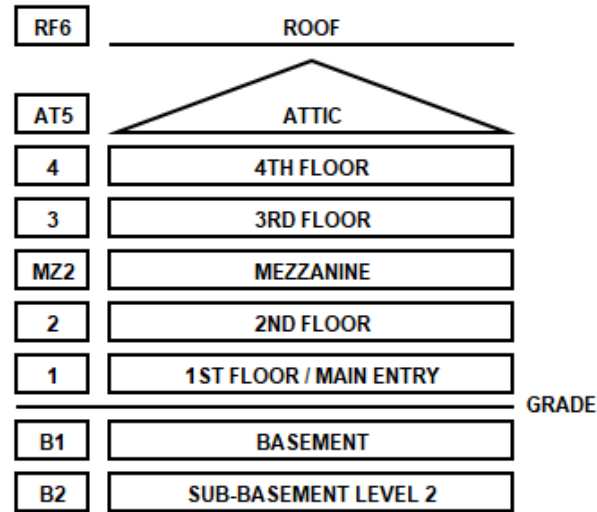

Figure 3A

4. ROOM NUMBERING

The guidelines in this section should be followed closely as possible when assigning numbers to individual rooms.

Rooms are numbered using a standard three-digit number (plus optional alpha suffix) consistently throughout the building. The first floor will be numbered 100's, the second floor will be 200's, third floor 300's, etc. Basement level will be B100's, etc.

The first number is the floor, and the subsequent two numbers are the unique room identifier on that floor (e.g., 301, 302, 318). When a building has more than 9 floors above grade, a four-digit number may be used. In this case the first two numbers would represent the floor (e.g., 1101, 1102, 1118).

To the greatest extent possible, rooms with the same digits in the last two positions should be in the same position in the building (e.g., rooms 110, 210, and 310 should all occur in the same vertical stack).

Each room should have only one number assigned to it, regardless of the number of doors opening into it.

4.1 BUILDINGS WITH ONE MAIN CORRIDOR

In a building with one main corridor room numbers should start at the main entrance and increase as you move away from the entrance. Use odd numbers on the left side of the corridor and even numbers on the right. See *Figure 4B*.

ACCS INSTRUCTIONS TO ARCHITECTS AND ENGINEERS

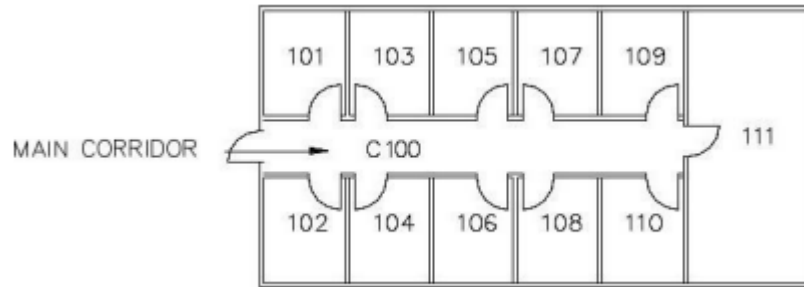

Figure 4B

In the case of a “racetrack” corridor design, starting at the main entrance room numbers will be numbered with even numbers down the corridor on the right and odd numbers down the left. These numbers will alternate back and forth across the corridor. See *Figure 4C*.

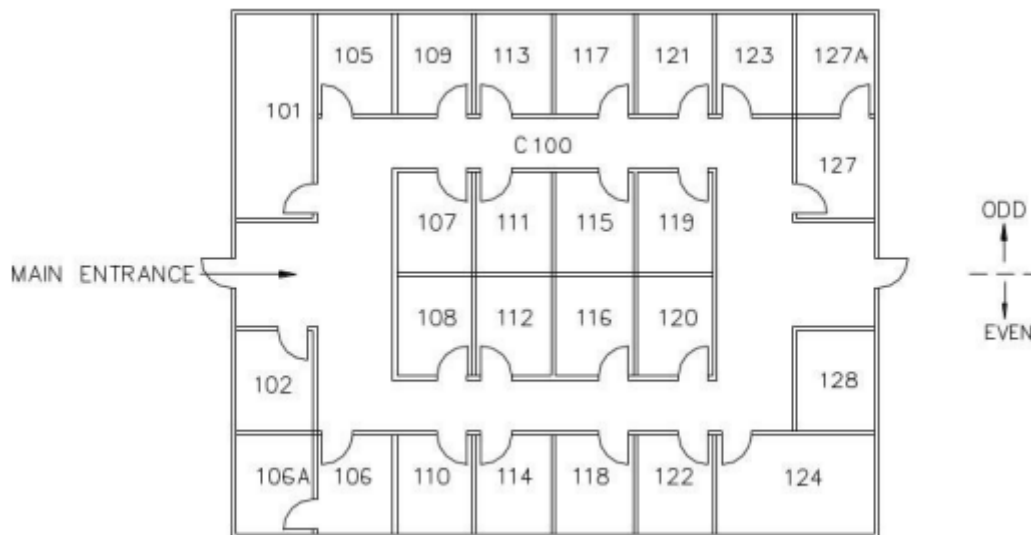

Figure 4C

4.2 BUILDINGS WITH MULTIPLE CORRIDORS

In a building with more than one corridor, numbers should follow in an ascending order in a clockwise direction from the main entrance. See *Figure 4D*.

ACCS INSTRUCTIONS TO ARCHITECTS AND ENGINEERS

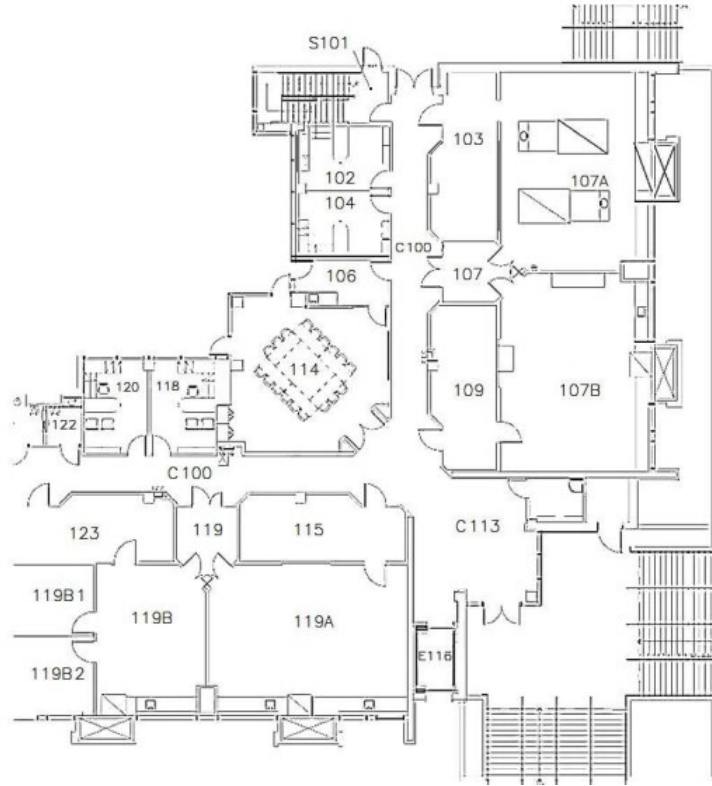

Figure 4D

4.3 SKIP NUMBERS TO MAINTAIN SUCCESSION AND FOR FUTURE RENOVATION

When a corridor contains large rooms such as classrooms, meeting rooms, and suites, room numbers shall be skipped to maintain succession and allow for future renovation of a larger space into smaller spaces. Sufficient numbers shall be reserved to allow for the larger spaces to be divided into standard smaller spaces. See *Figure 4E*.

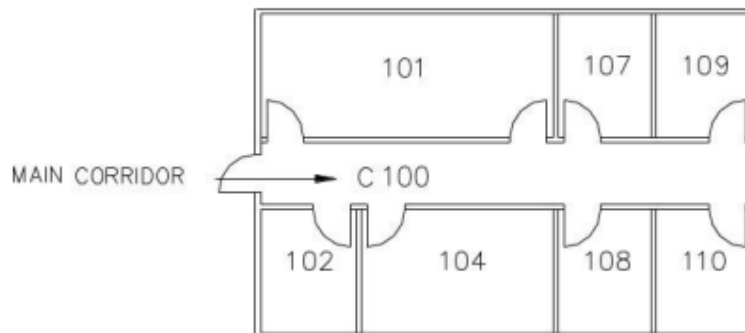

Figure 4E

ACCS INSTRUCTIONS TO ARCHITECTS AND ENGINEERS

4.4 SUITES

Suites are spaces that have one entrance with one primary room and more than one sub-room within. Rooms entered from a main corridor or lobby are numbered with no letter suffix. When rooms open off to another room and not from a corridor (such as in a suite of offices), use the number of the main room with a letter suffix (example: Reception 301, Office 301A, Office 301B, Office Storage 301C). Rooms inside sub-rooms are numbered with an additional letter (e.g., 307AA). Avoid the use of letters “I” and “O” which may be interpreted as numbers. Where possible, assign suffix letters in the order rooms are encountered, in the same direction as the overall numbering sequence, preferably clockwise. Thus, in the case where the first room already has a suffix, the next alphabetic designation shall be used. See *Figure 4F*.

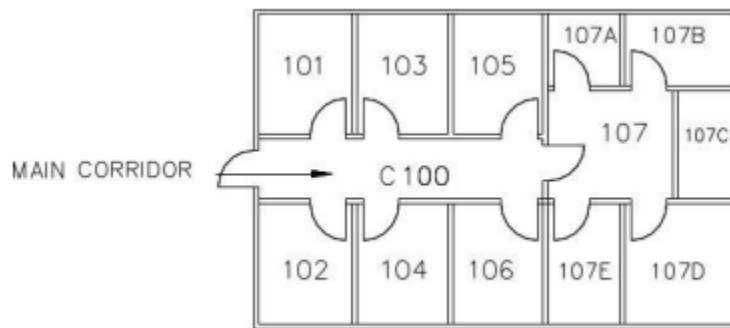

Figure 4F

4.5 ACCESSIBLE SPACES

In addition to rooms, all interior spaces that can be directly accessed such as corridors, stairwells, elevator shafts and accessible pipe spaces should be numbered in a manner as consistent as possible with standard room spaces. Where doors or walls separate different areas of these spaces, each area should receive its own unique number. These spaces will be identified with a 1 or 2-character prefix followed by the standard century numbers that flow with the rest of the room numbering on that floor. A listing of these prefixes can be found in *Figure 4G*.

4.6 NON-ASSIGNABLE SPACES

Non-assignable spaces (according to the Postsecondary Education Facilities Inventory and Classification Manual (FICM), 2006 Edition) shall be identified with a 1 or 2-character prefix followed by the standard century numbers that flow with the rest of the room numbering on that floor. Like assignable spaces, non-assignable spaces shall be aligned vertically where possible. For example, a continuous stairway shall be numbered accordingly on each floor: S101, S201, S301, etc. A listing of these prefixes can be found in *Figure 4G*.



ACCS INSTRUCTIONS TO ARCHITECTS AND ENGINEERS

<i>FICM Classification</i>	<i>Description</i>	<i>Prefix</i>	<i>Room Number Examples</i>
Circulation Areas			
W01	Bridge	BR	BR200, BR230
W01	Tunnel	TN	TN200, TN233
W02	Elevator	E	E204, E245
W03	Escalator	ES	ES201, ES246
W04	Loading Dock	LD	LD224, LD232
W05	Lobby	LB	LB200, LB228
W06	Corridor	C	C200, C201
W07	Stairway	S	S201, S237
Building Service Areas			
X01	Storage/Supply Room	SR	SR231, SR242A
X02	Custodial Room	CR	CR233, CR241B
X03	Restroom	R	R216, R218
Mechanical Area			
Y01	Central Utility Plant	UT	UT200, UT210
Y03	Shaft	SH	SH223, SH234
Y04	Mechanical/Utility Space	M	M209, M217A

Figure 4G

5. CONFLICTS AND REVIEW

In the case of conflicts or questions, ACCS Facilities Division should be consulted and will provide guidance for determining an appropriate room numbering scheme to be implemented. Any changes affecting building or room numbering should be reviewed by ACCS Facilities Division before proceeding with a project, assigning new buildings or room numbers, or implementing any room number changes.



ACCS INSTRUCTIONS TO ARCHITECTS AND ENGINEERS

ACCS Facilities Project File Naming Standard

The following are standard requirements associated with numbering, tracking and distributing project related documents between ACCS, College leaders, Design Professionals, Contractors, Sub-Contractors and other project stakeholders.

ACCS Project Number: The ACCS Facilities Division utilizes a seven (7) digit project numbering system followed by the three (3) to six (6) digit VPDI Code. The Project Number is established by the ACCS Facilities Division and should be used in **ALL** correspondence (email, written letters, file naming) to facilitate efficient project management. The ACCS Project Number should follow any file name abbreviations.

The ACCS Project Number format: **2021001 ACCSO**

- a.) First Four digits for the Calendar Year that the project was established, **2021** in the example.
- b.) Next Three digits are the sequential project number, **001** in the example.
- c.) Three to Six characters that reflect the individual College Banner System Identifier (VPDI Code), **ACCSO** in the example.

<i>Name of College/Institution</i>	<i>VPDI Code</i>
ACCS System Office	ACCSO
Alabama Technology Network	ATN
Bishop State Community College	BISHOP
Bevill State Community College	BSCC
Central Alabama Community College	CACC
Calhoun Community College	CCC
Coastal Alabama Community College	COASTL
Chattahoochee Valley Community College	CVCC
J. F. Drake State Community & Technical College	DRAKE
Enterprise State Community College	ESCC
Gadsden State Community College	GSCC
J. F. Ingram State Technical College	ISTC
Jefferson State Community College	JSCC
T. A. Lawson State Community College	LAWSON
Lurleen B. Wallace Community College	LBWCC
Marion Military Institute	MMI
Northeast Alabama Community College	NACC
Northwest Shoals Community College	NWSCC
Reid State Community College	RSTC
Snead State Community College	SNEAD
Shelton State Community College	SSCC
Southern Union State Community College	SUSCC
H. Councill Trenholm State Community College	TSCC
George C. Wallace Community College	WCC
George Corley Wallace State Community College	WCCS
Wallace State Community College	WSCC



ACCS INSTRUCTIONS TO ARCHITECTS AND ENGINEERS

Document Abbreviations: Common project files that are saved in project folders should try to use the same abbreviations for clarity and efficiency when such files are shared amongst a group of individuals. Below are some common files and suggested abbreviations:

<i>Document/Explanation</i>	<i>Abbreviation</i>	<i>Example</i>
PROJECT NUMBER (YEARNUM VPDI) - last part of every file name		2024103 COASTL
PROJECT REQUEST FORM (for future revisions, add the next consecutive number after the abbrev.)	PRF	PRF 2024103 COASTL
MEMORANDUM OF AGREEMENT	MOA	MOA 2025012 LAWSON
PROGRAMMING	PROG	PROG 2022102 CVCC
AGREEMENT BETWEEN OWNER AND ARCHITECT (followed by name of Design Professional)	OA	OA <i>Architect</i> 2023107 JSCC
AMENDMENT (followed by # and then name of Design Professional)	AMEND	AMEND1 <i>Architect</i> 2023107 JSCC
CONSTRUCTION CONTRACT (followed by name of the Contractor)	CC	CC <i>Contractor</i> 2025023 WCC
CONTRACT CHANGE ORDER (followed by number and then name of Contractor)	CO	CO8 <i>Contractor</i> 2022086 DRAKE
CHANGE ORDER REQUEST (followed by the #)	COR	COR4 2023045 ESCC
CHANGE ORDER JUSTIFICATION (followed by the #)	COJ	COJ2 2024024 ITSC
SCHEMATIC DESIGN	SD	SD 2023087 MMI
SCHEMATIC DESIGN CHECKLIST	SDCHK	SDCHK 2023087 MMI
PRELIMINARY DESIGN	PD	PD 2022011 NACC
PRELIMINARY DESIGN CHECKLIST	PDCHK	PDCHK 2022011 NACC
FINAL DESIGN	FD	FD 2024055 LAWSON
FINAL DESIGN CHECKLIST	FDCHK	FDCHK 2024055 LAWSON
DESIGN SCHEDULE	DSCHED	DSCHED 2024125 NACC
NOTICE OF UPCOMING PROJECT	NOUP	NOUP 2022112 LBWCC
BID ADVERTISEMENT	BIDAD	BIDAD 2025002 NWSCC
PREQUALIFICATION	PREQUAL	PREQUAL 2024098 CCC
BID DOCUMENTS	BD	BD 2023077 WCCS
ADDENDUM (followed by #)	ADD	ADD3 2024036 BISHOP
PRE BID MEETING (minutes, etc.)	PREBID	PREBID 2022134 BSCC
BID TABULATION	BIDTAB	BIDTAB 2023008 SNEAD
NOTICE OF AWARD	NOA	NOA 2024005 SSSC
CONFORMANCE DOCUMENTS	CONF	CONF 2024077 TSCC
NOTICE TO PROCEED (followed by name of Contractor)	NTP	NTP <i>Contractor</i> 2023092 WSCC
CONSTRUCTION SCHEDULE	CSCHEd	CSCHEd 2025042 CACC
PRE CONSTRUCTION MEETING	PRECON	PRECON 2023106 RSTC
PRE CONSTRUCTION CHECKLIST	PCCHK	PCCHK 2021033 ESCC
APPLICATION AND CERTIFICATE OF PAYMENT (followed by # and name of company)	PAYAPP	PAYAPP7 <i>Company</i> 2024015 TSCC
CERTIFICATE OF SUBSTANTIAL COMPLETION (followed by name of the Contractor)	COSC	COSC <i>Contractor</i> 2024029 SUSCC
ADVERTISEMENT FOR COMPLETION	ADCOMP	ADCOMP 2022110 CACC
FINAL PUNCH LIST	FPL	FPL 2024035 GSTC
ONE YEAR INSPECTION	1YR	1YR 2023059 LBWCC
AS BUILTS	AB	AB 2023157 SNEAD



ACCS INSTRUCTIONS TO ARCHITECTS AND ENGINEERS

Shared Files: Files that are shared amongst a group of individuals and revised frequently need a way to distinguish the different versions. When a shared file is opened and edited, the new file should be saved with the following eleven (11) character suffix: **2024Mar06 MT**

- a.) Four digits for the Calendar Year when the file was edited, **2024** in the example.
- b.) Three characters for the Month when file was edited, **Mar** in the example.
- c.) Two digits for the Day when the file was edited, **06** in the example.
- d.) Two characters for the Initials of who edited the file, **MT** in the example.

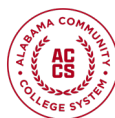

ACCS INSTRUCTIONS TO ARCHITECTS AND ENGINEERS

CHECKLIST

YES	NO	N/A	STANDARD TOPIC
<input type="checkbox"/>	<input type="checkbox"/>	<input type="checkbox"/>	GENERAL
<input type="checkbox"/>	<input type="checkbox"/>	<input type="checkbox"/>	Document Purpose
<input type="checkbox"/>	<input type="checkbox"/>	<input type="checkbox"/>	Space Type
<input type="checkbox"/>	<input type="checkbox"/>	<input type="checkbox"/>	A10 Foundations
<input type="checkbox"/>	<input type="checkbox"/>	<input type="checkbox"/>	A1010 Standard Foundations
<input type="checkbox"/>	<input type="checkbox"/>	<input type="checkbox"/>	A1020 Special Foundations
<input type="checkbox"/>	<input type="checkbox"/>	<input type="checkbox"/>	A1030 Slab on Grade
<input type="checkbox"/>	<input type="checkbox"/>	<input type="checkbox"/>	A20 Basement Construction
<input type="checkbox"/>	<input type="checkbox"/>	<input type="checkbox"/>	A2010 Basement Excavation
<input type="checkbox"/>	<input type="checkbox"/>	<input type="checkbox"/>	A2020 Basement Walls
<input type="checkbox"/>	<input type="checkbox"/>	<input type="checkbox"/>	B10 Superstructure
<input type="checkbox"/>	<input type="checkbox"/>	<input type="checkbox"/>	B1010 Floor Construction
<input type="checkbox"/>	<input type="checkbox"/>	<input type="checkbox"/>	B1020 Roof Construction
<input type="checkbox"/>	<input type="checkbox"/>	<input type="checkbox"/>	B20 Exterior Enclosure
<input type="checkbox"/>	<input type="checkbox"/>	<input type="checkbox"/>	B2010 Exterior Walls
<input type="checkbox"/>	<input type="checkbox"/>	<input type="checkbox"/>	B2020 Exterior Windows
<input type="checkbox"/>	<input type="checkbox"/>	<input type="checkbox"/>	B2030 Exterior Doors
<input type="checkbox"/>	<input type="checkbox"/>	<input type="checkbox"/>	B30 Roofing
<input type="checkbox"/>	<input type="checkbox"/>	<input type="checkbox"/>	B3010 Roof Coverings
<input type="checkbox"/>	<input type="checkbox"/>	<input type="checkbox"/>	B3020 Roof Openings
<input type="checkbox"/>	<input type="checkbox"/>	<input type="checkbox"/>	C10 Interior Construction
<input type="checkbox"/>	<input type="checkbox"/>	<input type="checkbox"/>	C1010 Partitions
<input type="checkbox"/>	<input type="checkbox"/>	<input type="checkbox"/>	C1020 Interior Doors
<input type="checkbox"/>	<input type="checkbox"/>	<input type="checkbox"/>	C1030 Fittings
<input type="checkbox"/>	<input type="checkbox"/>	<input type="checkbox"/>	C20 Stairs
<input type="checkbox"/>	<input type="checkbox"/>	<input type="checkbox"/>	C2010 Stair Construction

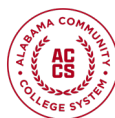

ACCS INSTRUCTIONS TO ARCHITECTS AND ENGINEERS

YES	NO	N/A	STANDARD TOPIC
<input type="checkbox"/>	<input type="checkbox"/>	<input type="checkbox"/>	C2020 Stair Finishes
<input type="checkbox"/>	<input type="checkbox"/>	<input type="checkbox"/>	C30 Interior Finishes
<input type="checkbox"/>	<input type="checkbox"/>	<input type="checkbox"/>	C3010 Wall Finishes
<input type="checkbox"/>	<input type="checkbox"/>	<input type="checkbox"/>	C3020 Floor Finishes
<input type="checkbox"/>	<input type="checkbox"/>	<input type="checkbox"/>	C3030 Ceiling Finishes
<input type="checkbox"/>	<input type="checkbox"/>	<input type="checkbox"/>	D10 Conveying
<input type="checkbox"/>	<input type="checkbox"/>	<input type="checkbox"/>	D1010 Elevators & Lifts
<input type="checkbox"/>	<input type="checkbox"/>	<input type="checkbox"/>	D1020 Escalators & Lifts
<input type="checkbox"/>	<input type="checkbox"/>	<input type="checkbox"/>	D1030 Other Conveying Systems
<input type="checkbox"/>	<input type="checkbox"/>	<input type="checkbox"/>	D20 Plumbing
<input type="checkbox"/>	<input type="checkbox"/>	<input type="checkbox"/>	D2010 Plumbing Fixtures
<input type="checkbox"/>	<input type="checkbox"/>	<input type="checkbox"/>	D2020 Domestic Water Distribution
<input type="checkbox"/>	<input type="checkbox"/>	<input type="checkbox"/>	D2030 Sanitary Waste
<input type="checkbox"/>	<input type="checkbox"/>	<input type="checkbox"/>	D2040 Rain Water Damage
<input type="checkbox"/>	<input type="checkbox"/>	<input type="checkbox"/>	D2090 Other Plumbing Systems
<input type="checkbox"/>	<input type="checkbox"/>	<input type="checkbox"/>	D30 HVAC
<input type="checkbox"/>	<input type="checkbox"/>	<input type="checkbox"/>	D3010 Energy Supply
<input type="checkbox"/>	<input type="checkbox"/>	<input type="checkbox"/>	D3020 Heat Generating Systems
<input type="checkbox"/>	<input type="checkbox"/>	<input type="checkbox"/>	D3030 Cooling Generating Systems
<input type="checkbox"/>	<input type="checkbox"/>	<input type="checkbox"/>	D3040 Distribution Systems
<input type="checkbox"/>	<input type="checkbox"/>	<input type="checkbox"/>	D3050 Terminal & Package Units
<input type="checkbox"/>	<input type="checkbox"/>	<input type="checkbox"/>	D3060 Controls & Instrumentation
<input type="checkbox"/>	<input type="checkbox"/>	<input type="checkbox"/>	D3070 Systems Testing & Balancing
<input type="checkbox"/>	<input type="checkbox"/>	<input type="checkbox"/>	D3090 Other HVAC Systems & Equipment
<input type="checkbox"/>	<input type="checkbox"/>	<input type="checkbox"/>	D40 Fire Protection
<input type="checkbox"/>	<input type="checkbox"/>	<input type="checkbox"/>	D4010 Sprinklers
<input type="checkbox"/>	<input type="checkbox"/>	<input type="checkbox"/>	D4020 Standpipes
<input type="checkbox"/>	<input type="checkbox"/>	<input type="checkbox"/>	D4030 Fire Protection Specialties

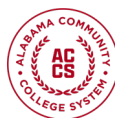

ACCS INSTRUCTIONS TO ARCHITECTS AND ENGINEERS

YES	NO	N/A	STANDARD TOPIC
<input type="checkbox"/>	<input type="checkbox"/>	<input type="checkbox"/>	D4090 Other Fire Protection Systems
<input type="checkbox"/>	<input type="checkbox"/>	<input type="checkbox"/>	D50 Electrical
<input type="checkbox"/>	<input type="checkbox"/>	<input type="checkbox"/>	D5010 Electrical Service & Distribution
<input type="checkbox"/>	<input type="checkbox"/>	<input type="checkbox"/>	D5020 Lighting and Branch Wiring
<input type="checkbox"/>	<input type="checkbox"/>	<input type="checkbox"/>	D5030 Communication & Security
<input type="checkbox"/>	<input type="checkbox"/>	<input type="checkbox"/>	D5090 Other Electrical Systems
<input type="checkbox"/>	<input type="checkbox"/>	<input type="checkbox"/>	E10 Equipment
<input type="checkbox"/>	<input type="checkbox"/>	<input type="checkbox"/>	E1010 Commercial Equipment
<input type="checkbox"/>	<input type="checkbox"/>	<input type="checkbox"/>	E1020 Institutional Equipment
<input type="checkbox"/>	<input type="checkbox"/>	<input type="checkbox"/>	E1030 Vehicular Equipment
<input type="checkbox"/>	<input type="checkbox"/>	<input type="checkbox"/>	E1090 Other Equipment
<input type="checkbox"/>	<input type="checkbox"/>	<input type="checkbox"/>	E20 Furnishings
<input type="checkbox"/>	<input type="checkbox"/>	<input type="checkbox"/>	E2010 Fixed Furnishings
<input type="checkbox"/>	<input type="checkbox"/>	<input type="checkbox"/>	E2020 Movable Furnishings
<input type="checkbox"/>	<input type="checkbox"/>	<input type="checkbox"/>	F10 Special Construction
<input type="checkbox"/>	<input type="checkbox"/>	<input type="checkbox"/>	F1010 Special Structures
<input type="checkbox"/>	<input type="checkbox"/>	<input type="checkbox"/>	F1020 Integrated Construction
<input type="checkbox"/>	<input type="checkbox"/>	<input type="checkbox"/>	F1030 Special Construction Systems
<input type="checkbox"/>	<input type="checkbox"/>	<input type="checkbox"/>	F1040 Special Facilities
<input type="checkbox"/>	<input type="checkbox"/>	<input type="checkbox"/>	F1050 Special Controls and Instrumentation
<input type="checkbox"/>	<input type="checkbox"/>	<input type="checkbox"/>	F20 Selective Building Demolition
<input type="checkbox"/>	<input type="checkbox"/>	<input type="checkbox"/>	F2010 Building Elements Demolition
<input type="checkbox"/>	<input type="checkbox"/>	<input type="checkbox"/>	F2020 Hazardous Components Abatement
<input type="checkbox"/>	<input type="checkbox"/>	<input type="checkbox"/>	G10 Site Preparation
<input type="checkbox"/>	<input type="checkbox"/>	<input type="checkbox"/>	G1010 Site Clearing
<input type="checkbox"/>	<input type="checkbox"/>	<input type="checkbox"/>	G1020 Site Demolition and Relocations
<input type="checkbox"/>	<input type="checkbox"/>	<input type="checkbox"/>	G1030 Site Earthwork
<input type="checkbox"/>	<input type="checkbox"/>	<input type="checkbox"/>	G1040 Hazardous Waste Remediation

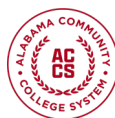

ACCS INSTRUCTIONS TO ARCHITECTS AND ENGINEERS

YES	NO	N/A	STANDARD TOPIC
<input type="checkbox"/>	<input type="checkbox"/>	<input type="checkbox"/>	G20 Site Improvements
<input type="checkbox"/>	<input type="checkbox"/>	<input type="checkbox"/>	G2010 Roadways
<input type="checkbox"/>	<input type="checkbox"/>	<input type="checkbox"/>	G2020 Parking Lots
<input type="checkbox"/>	<input type="checkbox"/>	<input type="checkbox"/>	G2030 Pedestrian Paving
<input type="checkbox"/>	<input type="checkbox"/>	<input type="checkbox"/>	G2040 Site Development
<input type="checkbox"/>	<input type="checkbox"/>	<input type="checkbox"/>	G2050 Landscaping
<input type="checkbox"/>	<input type="checkbox"/>	<input type="checkbox"/>	G30 Site Mechanical Utilities
<input type="checkbox"/>	<input type="checkbox"/>	<input type="checkbox"/>	G3010 Water Supply
<input type="checkbox"/>	<input type="checkbox"/>	<input type="checkbox"/>	G3020 Sanitary Sewer
<input type="checkbox"/>	<input type="checkbox"/>	<input type="checkbox"/>	G3030 Storm Sewer
<input type="checkbox"/>	<input type="checkbox"/>	<input type="checkbox"/>	G3040 Heating Distribution
<input type="checkbox"/>	<input type="checkbox"/>	<input type="checkbox"/>	G3050 Cooling Distribution
<input type="checkbox"/>	<input type="checkbox"/>	<input type="checkbox"/>	G3060 Fuel Distribution
<input type="checkbox"/>	<input type="checkbox"/>	<input type="checkbox"/>	G3090 Other Site Mechanical Utilities
<input type="checkbox"/>	<input type="checkbox"/>	<input type="checkbox"/>	G40 Site Electrical Utilities
<input type="checkbox"/>	<input type="checkbox"/>	<input type="checkbox"/>	G4010 Electrical Distribution
<input type="checkbox"/>	<input type="checkbox"/>	<input type="checkbox"/>	G4020 Site Lighting
<input type="checkbox"/>	<input type="checkbox"/>	<input type="checkbox"/>	G4030 Site Communications & Security
<input type="checkbox"/>	<input type="checkbox"/>	<input type="checkbox"/>	G4090 Other Site Electrical Utilities
<input type="checkbox"/>	<input type="checkbox"/>	<input type="checkbox"/>	G90 Other Site Constructions
<input type="checkbox"/>	<input type="checkbox"/>	<input type="checkbox"/>	G9010 Service and Pedestrian Tunnels
<input type="checkbox"/>	<input type="checkbox"/>	<input type="checkbox"/>	G9090 Other Site Systems & Equipment
<input type="checkbox"/>	<input type="checkbox"/>	<input type="checkbox"/>	SPACE NAMING GUIDELINES
<input type="checkbox"/>	<input type="checkbox"/>	<input type="checkbox"/>	ACCS Facilities Project File Naming Standard

